

TOSHIBA

Leading Innovation >>>

FILE NO. SVM-11012

SERVICE MANUAL



AIR-CONDITIONER

MULTI TYPE

< Console Type >

MML-AP0074NH-E, -TR

MML-AP0094NH-E, -TR

MML-AP0124NH-E, -TR

MML-AP0154NH-E, -TR

MML-AP0184NH-E, -TR

- This Service Manual describes contents of the new Console indoor unit.
For the outdoor unit, refer to the Manual with **FILE NO. A10-005, A07-004, A05-015.**
- **The service parts will be supplied by TCTC.**

CONTENTS

Warning Indications on the Air Conditioner Unit	4
1. PRECAUTIONS FOR SAFETY	5
2. SPECIFICATIONS	13
3. CONSTRUCTION VIEWS (EXTERNAL VIEWS).....	15
4. WIRING DIAGRAM	16
5. PART RATING	17
6. REFRIGERATING CYCLE DIAGRAM	34
7. CONTROL OUTLINE	35
8. CONFIGURATION OF CONTROL CIRCUIT.....	42
9. APPLIED CONTROL	48
10. TROUBLESHOOTING	60
11. OWNNER'S MANUAL.....	85
12. INSTALLATION MANUAL.....	96
13. P.C. BOARD EXCHANGE PROCEDURES	111
14. DETACHMENTS	116
15. EXPLODED VIEWS AND PARTS LIST.....	127

Original instructions

Please read carefully through these instructions that contain important information which complies with the “Machinery“ Directive (Directive 2006/42/EC), and ensure that you understand them.

Some of the details provided in these instructions differ from the service manual, and the instructions provided here take precedence.

Generic Denomination: Air Conditioner

Definition of Qualified Installer or Qualified Service Person

The air conditioner must be installed, maintained, repaired and removed by a qualified installer or qualified service person. When any of these jobs is to be done, ask a qualified installer or qualified service person to do them for you. A qualified installer or qualified service person is an agent who has the qualifications and knowledge described in the table below.

Agent	Qualifications and knowledge which the agent must have
Qualified installer	<ul style="list-style-type: none"> • The qualified installer is a person who installs, maintains, relocates and removes the air conditioners made by Toshiba Carrier Corporation. He or she has been trained to install, maintain, relocate and remove the air conditioners made by Toshiba Carrier Corporation or, alternatively, he or she has been instructed in such operations by an individual or individuals who have been trained and is thus thoroughly acquainted with the knowledge related to these operations. • The qualified installer who is allowed to do the electrical work involved in installation, relocation and removal has the qualifications pertaining to this electrical work as stipulated by the local laws and regulations, and he or she is a person who has been trained in matters relating to electrical work on the air conditioners made by Toshiba Carrier Corporation or, alternatively, he or she has been instructed in such matters by an individual or individuals who have been trained and is thus thoroughly acquainted with the knowledge related to this work. • The qualified installer who is allowed to do the refrigerant handling and piping work involved in installation, relocation and removal has the qualifications pertaining to this refrigerant handling and piping work as stipulated by the local laws and regulations, and he or she is a person who has been trained in matters relating to refrigerant handling and piping work on the air conditioners made by Toshiba Carrier Corporation or, alternatively, he or she has been instructed in such matters by an individual or individuals who have been trained and is thus thoroughly acquainted with the knowledge related to this work. • The qualified installer who is allowed to work at heights has been trained in matters relating to working at heights with the air conditioners made by Toshiba Carrier Corporation or, alternatively, he or she has been instructed in such matters by an individual or individuals who have been trained and is thus thoroughly acquainted with the knowledge related to this work.
Qualified service person	<ul style="list-style-type: none"> • The qualified service person is a person who installs, repairs, maintains, relocates and removes the air conditioners made by Toshiba Carrier Corporation. He or she has been trained to install, repair, maintain, relocate and remove the air conditioners made by Toshiba Carrier Corporation or, alternatively, he or she has been instructed in such operations by an individual or individuals who have been trained and is thus thoroughly acquainted with the knowledge related to these operations. • The qualified service person who is allowed to do the electrical work involved in installation, repair, relocation and removal has the qualifications pertaining to this electrical work as stipulated by the local laws and regulations, and he or she is a person who has been trained in matters relating to electrical work on the air conditioners made by Toshiba Carrier Corporation or, alternatively, he or she has been instructed in such matters by an individual or individuals who have been trained and is thus thoroughly acquainted with the knowledge related to this work. • The qualified service person who is allowed to do the refrigerant handling and piping work involved in installation, repair, relocation and removal has the qualifications pertaining to this refrigerant handling and piping work as stipulated by the local laws and regulations, and he or she is a person who has been trained in matters relating to refrigerant handling and piping work on the air conditioners made by Toshiba Carrier Corporation or, alternatively, he or she has been instructed in such matters by an individual or individuals who have been trained and is thus thoroughly acquainted with the knowledge related to this work. • The qualified service person who is allowed to work at heights has been trained in matters relating to working at heights with the air conditioners made by Toshiba Carrier Corporation or, alternatively, he or she has been instructed in such matters by an individual or individuals who have been trained and is thus thoroughly acquainted with the knowledge related to this work.

Definition of Protective Gear

When the air conditioner is to be transported, installed, maintained, repaired or removed, wear protective gloves and 'safety' work clothing.



In addition to such normal protective gear, wear the protective gear described below when undertaking the special work detailed in the table below.

Failure to wear the proper protective gear is dangerous because you will be more susceptible to injury, burns, electric shocks and other injuries.

Work undertaken	Protective gear worn
All types of work	Protective gloves 'Safety' working clothing
Electrical-related work	Gloves to provide protection for electricians and from heat Insulating shoes Clothing to provide protection from electric shock
Work done at heights (50 cm or more)	Helmets for use in industry
Transportation of heavy objects	Shoes with additional protective toe cap
Repair of outdoor unit	Gloves to provide protection for electricians and from heat



The important contents concerned to the safety are described on the product itself and on this Service Manual. Please read this Service Manual after understanding the described items thoroughly in the following contents (Indications/Illustrated marks), and keep them.

[Explanation of indications]

Indication	Explanation
 DANGER	Indicates contents assumed that an imminent danger causing a death or serious injury of the repair engineers and the third parties when an incorrect work has been executed.
 WARNING	Indicates possibilities assumed that a danger causing a death or serious injury of the repair engineers, the third parties, and the users due to troubles of the product after work when an incorrect work has been executed.
 CAUTION	Indicates contents assumed that an injury or property damage (*) may be caused on the repair engineers, the third parties, and the users due to troubles of the product after work when an incorrect work has been executed.

* Property damage: Enlarged damage concerned to property, furniture, and domestic animal/pet

[Explanation of illustrated marks]



Mark	Explanation
	Indicates prohibited items (Forbidden items to do) The sentences near an illustrated mark describe the concrete prohibited contents.
	Indicates mandatory items (Compulsory items to do) The sentences near an illustrated mark describe the concrete mandatory contents.
	Indicates cautions (Including danger/warning) The sentences or illustration near or in an illustrated mark describe the concrete cautious contents.

Warning Indications on the Air Conditioner Unit

[Confirmation of warning label on the main unit]

Confirm that labels are indicated on the specified positions

If removing the label during parts replace, stick it as the original.

Warning indication	Description								
 <table border="1" data-bbox="331 495 584 651"> <tr> <td colspan="2" style="text-align: center;">WARNING</td> </tr> <tr> <td colspan="2">ELECTRICAL SHOCK HAZARD</td> </tr> <tr> <td colspan="2">Disconnect all remote electric power supplies before servicing.</td> </tr> </table>	WARNING		ELECTRICAL SHOCK HAZARD		Disconnect all remote electric power supplies before servicing.		<p>WARNING</p> <p>ELECTRICAL SHOCK HAZARD Disconnect all remote electric power supplies before servicing.</p>		
WARNING									
ELECTRICAL SHOCK HAZARD									
Disconnect all remote electric power supplies before servicing.									
 <table border="1" data-bbox="331 705 584 862"> <tr> <td colspan="2" style="text-align: center;">WARNING</td> </tr> <tr> <td colspan="2">Moving parts.</td> </tr> <tr> <td colspan="2">Do not operate unit with grille removed.</td> </tr> <tr> <td colspan="2">Stop the unit before the servicing.</td> </tr> </table>	WARNING		Moving parts.		Do not operate unit with grille removed.		Stop the unit before the servicing.		<p>WARNING</p> <p>Moving parts. Do not operate unit with grille removed. Stop the unit before the servicing.</p>
WARNING									
Moving parts.									
Do not operate unit with grille removed.									
Stop the unit before the servicing.									
 <table border="1" data-bbox="331 916 584 1072"> <tr> <td colspan="2" style="text-align: center;">CAUTION</td> </tr> <tr> <td colspan="2">Do not touch the aluminum fins of the unit.</td> </tr> <tr> <td colspan="2">Doing so may result in injury.</td> </tr> </table>	CAUTION		Do not touch the aluminum fins of the unit.		Doing so may result in injury.		<p>CAUTION</p> <p>Do not touch the aluminium fins of the unit. Doing so may result in injury.</p>		
CAUTION									
Do not touch the aluminum fins of the unit.									
Doing so may result in injury.									





1. PRECAUTIONS FOR SAFETY

The manufacturer shall not assume any liability for the damage caused by not observing the description of this manual.



WARNING





 General	<p>Before starting to repair the air conditioner, read carefully through the Service Manual, and repair the air conditioner by following its instructions.</p>
	<p>Only qualified service person (*1) is allowed to repair the air conditioner. Repair of the air conditioner by unqualified person may give rise to a fire, electric shocks, injury, water leaks and/or other problems.</p>
	<p>Only a qualified installer (*1) or qualified service person (*1) is allowed to carry out the electrical work of the air conditioner. Under no circumstances must this work be done by an unqualified individual since failure to carry out the work properly may result in electric shocks and/or electrical leaks.</p>
	<p>Do not use any refrigerant different from the one specified for complement or replacement. Otherwise, abnormally high pressure may be generated in the refrigeration cycle, which may result in a failure or explosion of the product or an injury to your body.</p>
	<p>Wear protective gloves and safety work clothing during installation, servicing and removal.</p>
	<p>When connecting the electrical wires, repairing the electrical parts or undertaking other electrical jobs, wear gloves to provide protection for electricians and from heat, insulating shoes and clothing to provide protection from electric shocks. Failure to wear this protective gear may result in electric shocks.</p>
	<p>Electrical wiring work shall be conducted according to law and regulation in the community and installation manual. Failure to do so may result in electrocution or short circuit.</p>
	<p>Only a qualified installer (*1) or qualified service person (*1) is allowed to undertake work at heights using a stand of 50 cm or more or to remove the intake grille of the indoor unit to undertake work.</p>
	<p>When working at heights, use a ladder which complies with the ISO 14122 standard, and follow the procedure in the ladder's instructions. Also wear a helmet for use in industry as protective gear to undertake the work.</p>
	<p>When working at heights, put a sign in place so that no-one will approach the work location, before proceeding with the work. Parts and other objects may fall from above, possibly injuring a person below.</p>
	<p>When executing address setting, test run, or troubleshooting through the checking window on the electric parts box, put on insulated gloves to provide protection from electric shock. Otherwise you may receive an electric shock.</p>
	<p>Do not touch the aluminum fin of the unit. You may injure yourself if you do so. If the fin must be touched for some reason, first put on protective gloves and safety work clothing, and then proceed.</p>
	<p>Do not climb onto or place objects on top of the outdoor unit. You may fall or the objects may fall off of the outdoor unit and result in injury.</p>
	<p>When transporting the air conditioner, wear shoes with additional protective toe caps.</p>
	<p>Be sure that a heavy unit (10kg or heavier) such as a compressor is carried by two persons.</p>
	<p>This air conditioner has passed the pressure test as specified in IEC 60335-2-40 Annex EE.</p>
	<p>Use wiring that meets the specifications in the Installation Manual and the stipulations in the local regulations and laws. Use of wiring which does not meet the specifications may give rise to electric shocks, electrical leakage, smoking and/or a fire.</p>
<p>When checking the electric parts, removing the front panel of indoor unit and/or service panel of outdoor unit inevitably to determine the failure, use gloves to provide protection for electricians and from heat, insulating shoes, clothing to provide protection from electric shock and insulating tools. Be careful not to touch the live part. Electric shock may result. Only "Qualified service person" is allowed to do this work.</p>	
<p>When checking the electric parts, removing the front panel of indoor unit and/or service panel of outdoor unit inevitably to determine the failure, put a sign "Do not enter" around the site before the work. Failure to do this may result in third person getting electric shock.</p>	
<p>Refrigerant shall be replaced by nitrogen gas when repair with gas burner is needed. Oil attached to pipes may result in fire.</p>	
<p>Exchange to parts specified in service manual, which meet the specification or listed in parts list of service manual. Failure to use specified parts may result in electrical shock, smoke, and/or fire.</p>	





 **DANGER**

 Turn off breaker.	<p>Before carrying out the installation, maintenance, repair or removal work, be sure to set the circuit breaker for both the indoor and outdoor units to the OFF position. Otherwise, electric shocks may result.</p>
	<p>Before opening the front panel of the indoor unit or service panel of the outdoor unit, set the circuit breaker to the OFF position. Failure to set the circuit breaker to the OFF position may result in electric shocks through contact with the interior parts. Only a qualified installer (*1) or qualified service person (*1) is allowed to remove the intake grille of the indoor unit or service panel of the outdoor unit and do the work required.</p>
	<p>Before starting to repair the outdoor unit fan or fan guard, be absolutely sure to set the circuit breaker to the OFF position, and place a "Work in progress" sign on the circuit breaker.</p>
	<p>When cleaning the filter or other parts of the indoor unit, set the circuit breaker to OFF without fail, and place a "Work in progress" sign near the circuit breaker before proceeding with the work.</p>
	<p>When you have noticed that some kind of trouble (such as when an error display has appeared, there is a smell of burning, abnormal sounds are heard, the air conditioner fails to cool or heat or water is leaking) has occurred in the air conditioner, do not touch the air conditioner yourself but set the circuit breaker to the OFF position, and contact a qualified service person. Take steps to ensure that the power will not be turned on (by marking "out of service" near the circuit breaker, for instance) until qualified service person arrives. Continuing to use the air conditioner in the trouble status may cause mechanical problems to escalate or result in electric shocks or other failure.</p>
 Electric shock hazard	<p>When you access inside of the service panel to repair electric parts, wait for about five minutes after turning off the breaker. Do not start repairing immediately. Otherwise you may get electric shock by touching terminals of high-voltage capacitors. Natural discharge of the capacitor takes about five minutes.</p>
 Prohibition	<p>Place a "Work in progress" sign near the circuit breaker while the installation, maintenance, repair or removal work is being carried out. There is a danger of electric shocks if the circuit breaker is set to ON by mistake.</p>
	<p>Before operating the air conditioner after having completed the work, check that the front panel of the indoor unit and service panel of the outdoor unit are closed, and set the circuit breaker to the ON position. You may receive an electric shock if the power is turned on without first conducting these checks.</p>
 Stay on protection	<p>If, in the course of carrying out repairs, it becomes absolutely necessary to check out the electrical parts with the electrical parts box cover of one or more of the indoor units and the service panel of the outdoor unit removed in order to find out exactly where the trouble lies, wear insulated heat-resistant gloves, insulated boots and insulated work overalls, and take care to avoid touching any live parts. You may receive an electric shock if you fail to heed this warning. Only qualified service person (*1) is allowed to do this kind of work.</p>

 **WARNING**

 Check earth wires.	<p>Before troubleshooting or repair work, check the earth wire is connected to the earth terminals of the main unit, otherwise an electric shock is caused when a leak occurs. If the earth wire is not correctly connected, contact a qualified service person for rework.</p>
	<p>After completing the repair or relocation work, check that the ground wires are connected properly.</p>
	<p>Be sure to connect earth wire. (Grounding work) Incomplete grounding causes an electric shock. Do not connect ground wires to gas pipes, water pipes, and lightning rods or ground wires for telephone wires.</p>
 Prohibition of modification.	<p>Do not modify the products. Do not also disassemble or modify the parts. It may cause a fire, electric shock or injury.</p>
 Use specified parts.	<p>When any of the electrical parts are to be replaced, ensure that the replacement parts satisfy the specifications given in the Service Manual (or use the parts contained on the parts list in the Service Manual). Use of any parts which do not satisfy the required specifications may give rise to electric shocks, smoking and/or a fire.</p>

 Do not bring a child close to the equipment.	If, in the course of carrying out repairs, it becomes absolutely necessary to check out the electrical parts with the electrical parts box cover of one or more of the indoor units and the service panel of the outdoor unit removed in order to find out exactly where the trouble lies, put a sign in place so that no-one will approach the work location before proceeding with the work. Third-party individuals may enter the work site and receive electric shocks if this warning is not heeded.
 Insulating measures	Connect the cut-off lead wires with crimp contact, etc., put the closed end side upward and then apply a water-cut method, otherwise a leak or production of fire is caused at the users' side.
 No fire	When performing repairs using a gas burner, replace the refrigerant with nitrogen gas because the oil that coats the pipes may otherwise burn. When repairing the refrigerating cycle, take the following measures. 1) Be attentive to fire around the cycle. When using a gas stove, etc., be sure to put out fire before work; otherwise the oil mixed with refrigerant gas may catch fire. 2) Do not use a welder in the closed room. When using it without ventilation, carbon monoxide poisoning may be caused. 3) Do not bring inflammables close to the refrigerant cycle, otherwise fire of the welder may catch the inflammables.
 Refrigerant	The refrigerant used by this air conditioner is the R410A. Check the used refrigerant name and use tools and materials of the parts which match with it. For the products which use R410A refrigerant, the refrigerant name is indicated at a position on the outdoor unit where is easy to see. To prevent miss-charging, the route of the service port is changed from one of the former R22. For an air conditioner which uses R410A, never use other refrigerant than R410A. For an air conditioner which uses other refrigerant (R22, etc.), never use R410A. If different types of refrigerant are mixed, abnormal high pressure generates in the refrigerating cycle and an injury due to breakage may be caused. When the air conditioner has been installed or relocated, follow the instructions in the Installation Manual and purge the air completely so that no gases other than the refrigerant will be mixed in the refrigerating cycle. Failure to purge the air completely may cause the air conditioner to malfunction. Do not charge refrigerant additionally. If charging refrigerant additionally when refrigerant gas leaks, the refrigerant composition in the refrigerating cycle changes resulted in change of air conditioner characteristics or refrigerant over the specified standard amount is charged and an abnormal high pressure is applied to the inside of the refrigerating cycle resulted in cause of breakage or injury. Therefore if the refrigerant gas leaks, recover the refrigerant in the air conditioner, execute vacuuming, and then newly recharge the specified amount of liquid refrigerant. In this time, never charge the refrigerant over the specified amount. When recharging the refrigerant in the refrigerating cycle, do not mix the refrigerant or air other than R410A into the specified refrigerant. If air or others is mixed with the refrigerant, abnormal high pressure generates in the refrigerating cycle resulted in cause of injury due to breakage. After installation or servicing work, check the refrigerant gas does not leak. If the refrigerant gas leaks in the room, poisonous gas generates when gas touches to fire such as fan heater, stove or cooking stove though the refrigerant gas itself is innocuous. Never recover the refrigerant into the outdoor unit. When the equipment is moved or repaired, be sure to recover the refrigerant with recovering device. The refrigerant cannot be recovered in the outdoor unit; otherwise a serious accident such as breakage or injury is caused.
 Assembly/ Wiring	After repair work, surely assemble the disassembled parts, and connect and lead the removed wires as before. Perform the work so that the cabinet or panel does not catch the inner wires. If incorrect assembly or incorrect wire connection was done, a disaster such as a leak or fire is caused at user's side.
 Insulator check	After the work has finished, be sure to use an insulation tester set (500V Megger) to check the resistance is 1MΩ or more between the charge section and the non-charge metal section (Earth position). If the resistance value is low, a disaster such as a leak or electric shock is caused at user's side.
 Ventilation	When the refrigerant gas leaks during work, execute ventilation. If the refrigerant gas touches to a fire, poisonous gas generates. A case of leakage of the refrigerant and the closed room full with gas is dangerous because a shortage of oxygen occurs. Be sure to execute ventilation.

 Compulsion	<p>When the refrigerant gas leaks, find up the leaked position and repair it surely. If the leaked position cannot be found up and the repair work is interrupted, pump-down and tighten the service valve, otherwise the refrigerant gas may leak into the room. The poisonous gas generates when gas touches to fire such as fan heater, stove or cooking stove though the refrigerant gas itself is innocuous. When installing equipment which includes a large amount of charged refrigerant such as a multi air conditioner in a sub-room, it is necessary that the density does not the limit even if the refrigerant leaks. If the refrigerant leaks and exceeds the limit density, an accident of shortage of oxygen is caused.</p>
	<p>Tighten the flare nut with a torque wrench in the specified manner. Excessive tighten of the flare nut may cause a crack in the flare nut after a long period, which may result in refrigerant leakage.</p>
	<p>Nitrogen gas must be used for the airtight test.</p>
	<p>The charge hose must be connected in such a way that it is not slack.</p>
	<p>For the installation/moving/reinstallation work, follow to the Installation Manual. If an incorrect installation is done, a trouble of the refrigerating cycle, water leak, electric shock or fire is caused.</p>
 Check after repair	<p>Once the repair work has been completed, check for refrigerant leaks, and check the insulation resistance and water drainage. Then perform a trial run to check that the air conditioner is running properly.</p>
	<p>After repair work has finished, check there is no trouble. If check is not executed, a fire, electric shock or injury may be caused. For a check, turn off the power breaker.</p>
	<p>After repair work (installation of front panel and cabinet) has finished, execute a test run to check there is no generation of smoke or abnormal sound. If check is not executed, a fire or an electric shock is caused. Before test run, install the front panel and cabinet.</p>
	<p>Be sure to fix the screws back which have been removed for installation or other purposes.</p>
 Do not operate the unit with the valve closed.	<p>Check the following matters before a test run after repairing piping.</p> <ul style="list-style-type: none"> • Connect the pipes surely and there is no leak of refrigerant. • The valve is opened. <p>Running the compressor under condition that the valve closes causes an abnormal high pressure resulted in damage of the parts of the compressor and etc. and moreover if there is leak of refrigerant at connecting section of pipes, the air is sucked and causes further abnormal high pressure resulted in burst or injury.</p>
	<p>Only a qualified installer (*1) or qualified service person (*1) is allowed to relocate the air conditioner. It is dangerous for the air conditioner to be relocated by an unqualified individual since a fire, electric shocks, injury, water leakage, noise and/or vibration may result.</p>
 Check after reinstallation	<p>Check the following items after reinstallation.</p> <ol style="list-style-type: none"> 1) The earth wire is correctly connected. 2) The power cord is not caught in the product. 3) There is no inclination or unsteadiness and the installation is stable. <p>If check is not executed, a fire, an electric shock or an injury is caused.</p>
	<p>When carrying out the pump-down work shut down the compressor before disconnecting the refrigerant pipe. Disconnecting the refrigerant pipe with the service valve left open and the compressor still operating will cause air, etc. to be sucked in, raising the pressure inside the refrigeration cycle to an abnormally high level, and possibly resulting in reputing, injury, etc.</p>
 Cooling check	<p>When the service panel of the outdoor unit is to be opened in order for the compressor or the area around this part to be repaired immediately after the air conditioner has been shut down, set the circuit breaker to the OFF position, and then wait at least 10 minutes before opening the service panel. If you fail to heed this warning, you will run the risk of burning yourself because the compressor pipes and other parts will be very hot to the touch. In addition, before proceeding with the repair work, wear the kind of insulated heat-resistant gloves designed to protect electricians.</p>
	<p>Take care not to get burned by compressor pipes or other parts when checking the cooling cycle while running the unit as they get heated while running. Be sure to put on gloves providing protection for electric shock and heat.</p> <p>When the service panel of the outdoor unit is to be opened in order for the fan motor, reactor, inverter or the areas around these parts to be repaired immediately after the air conditioner has been shut down, set the circuit breaker to the OFF position, and then wait at least 10 minutes before opening the service panel. If you fail to heed this warning, you will run the risk of burning yourself because the fan motor, reactor, inverter heat sink and other parts will be very hot to the touch. In addition, before proceeding with the repair work, wear the kind of insulated heat-resistant gloves designed to protect electricians.</p>

 Installation	Only a qualified installer (*1) or qualified service person (*1) is allowed to install the air conditioner. If the air conditioner is installed by an unqualified individual, a fire, electric shocks, injury, water leakage, noise and/or vibration may result.
	Before starting to install the air conditioner, read carefully through the Installation Manual, and follow its instructions to install the air conditioner.
	Be sure to use the company-specified products for the separately purchased parts. Use of non-specified products may result in fire, electric shock, water leakage or other failure. Have the installation performed by a qualified installer.
	Do not supply power from the power terminal block equipped on the outdoor unit to another outdoor unit. Capacity overflow may occur on the terminal block and may result in fire.
	Do not install the air conditioner in a location that may be subject to a risk of exposure to a combustible gas. If a combustible gas leaks and becomes concentrated around the unit, a fire may occur.
	Install a circuit breaker that meets the specifications in the installation manual and the stipulations in the local regulations and laws.
	Install the circuit breaker where it can be easily accessed by the qualified service person (*1).
	If you install the unit in a small room, take appropriate measures to prevent the refrigerant from exceeding the limit concentration even if it leaks. Consult the dealer from whom you purchased the air conditioner when you implement the measures. Accumulation of highly concentrated refrigerant may cause an oxygen deficiency accident.
Do not place any combustion appliance in a place where it is directly exposed to the wind of air conditioner, otherwise it may cause imperfect combustion.	

Explanations given to user

- If you have discovered that the fan grille is damaged, do not approach the outdoor unit but set the circuit breaker to the OFF position, and contact a qualified service person to have the repairs done.
Do not set the circuit breaker to the ON position until the repairs are completed.

Relocation

- Only a qualified installer (*1) or qualified service person (*1) is allowed to relocate the air conditioner. It is dangerous for the air conditioner to be relocated by an unqualified individual since a fire, electric shocks, injury, water leakage, noise and/or vibration may result.
- When carrying out the pump-down work shut down the compressor before disconnecting the refrigerant pipe. Disconnecting the refrigerant pipe with the service valve left open and the compressor still operating will cause air, etc. to be sucked in, raising the pressure inside the refrigeration cycle to an abnormally high level, and possibly resulting in reputing, injury, etc.

(*1) Refer to the "Definition of Qualified Installer or Qualified Service Person."

SPECIFICATIONS

Model	Sound power level (dBA)		Weight (kg)
	Cooling	Heating	
MML-AP0074NH-E	*	*	17
MML-AP0074NH-TR	*	*	17
MML-AP0094NH-E	*	*	17
MML-AP0094NH-TR	*	*	17
MML-AP0124NH-E	*	*	17
MML-AP0124NH-TR	*	*	17
MML-AP0154NH-E	*	*	17
MML-AP0154NH-TR	*	*	17
MML-AP0184NH-E	*	*	17
MML-AP0184NH-TR	*	*	17

* Under 70 dBA

Declaration of Conformity

Manufacturer: TOSHIBA CARRIER (THAILAND) CO., LTD.
144/9 Moo 5, Bangkadi Industrial Park, Tivanon Road,
Amphur Muang, Pathumthani 12000, Thailand

Authorized Representative/
TCF holder: Nick Ball
Toshiba EMEA Engineering Director
Toshiba Carrier UK LTD.
Porsham Close, Belliver Industrial Estate,
PLYMOUTH, Devon, PL6 7DB.
United Kingdom

Hereby declares that the machinery described below:

Generic Denomination: Air Conditioner

Model/type: Indoor unit

MML-AP0074NH-E, MML-AP0094NH-E, MML-AP0124NH-E, MML-AP0154NH-E,
MML-AP0184NH-E, MML-AP0074NH-TR, MML-AP0094NH-TR, MML-AP0124NH-TR,
MML-AP0154NH-TR, MML-AP0184NH-TR

Commercial name: Super Modular Multi System Air Conditioner
Super Heat Recovery Multi System Air Conditioner
Mini-Super Modular Multi System Air Conditioner (MiNi-SMMS series)

Complies with the provisions of the "Machinery" Directive (Directive 2006/42/EC) and the regulations transposing into national law

Complies with the provisions of the following harmonized standard:
EN 378-2: 2008+A1:2009

NOTE

This declaration becomes invalid if technical or operational modifications are introduced without the manufacturer's consent.

• New Refrigerant (R410A)

This air conditioner adopts a new HFC type refrigerant (R410A) which does not deplete the ozone layer.

1. Safety Caution Concerned to New Refrigerant

The pressure of R410A is high 1.6 times of that of the former refrigerant (R22).

Accompanied with change of refrigerant, the refrigerating oil has been also changed.

Therefore, be sure that water, dust, the former refrigerant or the former refrigerating oil is not mixed into the refrigerating cycle of the air conditioner with new refrigerant during installation work or service work.

If an incorrect work or incorrect service is performed, there is a possibility to cause a serious accident.

Use the tools and materials exclusive to R410A to purpose a safe work.

2. Cautions on Installation/Service

(1) Do not mix the other refrigerant or refrigerating oil.

For the tools exclusive to R410A, shapes of all the joints including the service port differ from those of the former refrigerant in order to prevent mixture of them.

(2) As the use pressure of the new refrigerant is high, use material thickness of the pipe and tools which are specified for R410A.

(3) In the installation time, use clean pipe materials and work with great attention so that water and others do not mix in because pipes are affected by impurities such as water, oxide scales, oil, etc.

Use the clean pipes.

Be sure to brazing with flowing nitrogen gas. (Never use gas other than nitrogen gas.)

(4) For the earth protection, use a vacuum pump for air purge.

(5) R410A refrigerant is azeotropic mixture type refrigerant.

Therefore use liquid type to charge the refrigerant. (If using gas for charging, composition of the refrigerant changes and then characteristics of the air conditioner change.)

3. Pipe Materials

For the refrigerant pipes, copper pipe and joints are mainly used.

It is necessary to select the most appropriate pipes to conform to the standard.

Use clean material in which impurities adhere inside of pipe or joint to a minimum.

(1) Copper pipe

<Piping>

The pipe thickness, flare finishing size, flare nut and others differ according to a refrigerant type.

When using a long copper pipe for R410A, it is recommended to select "Copper or copper-base pipe without seam" and one with bonded oil amount 40mg/10m or less.

Also do not use crushed, deformed, discolored (especially inside) pipes. (Impurities cause clogging of expansion valves and capillary tubes.)

<Flare nut>

Use the flare nuts which are attached to the air conditioner unit.

(2) Joint

The flare joint and socket joint are used for joints of the copper pipe.

The joints are rarely used for installation of the air conditioner.

However clear impurities when using them.

4. Tools

(1) Required Tools for R410A

Mixing of different types of oil may cause a trouble such as generation of sludge, clogging of capillary, etc. Accordingly, the tools to be used are classified into the following three types.

- 1) Tools exclusive for R410A (Those which cannot be used for conventional refrigerant (R22))
- 2) Tools exclusive for R410A, but can be also used for conventional refrigerant (R22)
- 3) Tools commonly used for R410A and for conventional refrigerant (R22)

The table below shows the tools exclusive for R410A and their interchangeability.

Tools exclusive for R410A (The following tools for R410A are required.)

Tools whose specifications are changed for R410A and their interchangeability

No.	Used tool	Usage	R410A air conditioner installation		Conventional air conditioner installation
			Existence of new equipment for R410A	Whether conventional equipment can be used	Whether new equipment can be used with conventional refrigerant
①	Flare tool	Pipe flaring	Yes	*(Note 1)	Yes
②	Copper pipe gauge for adjusting projection margin	Flaring by conventional flare tool	Yes	*(Note 1)	*(Note 1)
③	Torque wrench	Connection of flare nut	Yes	No	No
④	Gauge manifold	Evacuating, refrigerant charge, run check, etc.	Yes	No	No
⑤	Charge hose				
⑥	Vacuum pump adapter	Vacuum evacuating	Yes	No	Yes
⑦	Electronic balance for refrigerant charging	Refrigerant charge	Yes	Yes	Yes
⑧	Refrigerant cylinder	Refrigerant charge	Yes	No	No
⑨	Leakage detector	Gas leakage check	Yes	No	Yes
⑩	Charging cylinder	Refrigerant charge	(Note 2)	No	No

(Note 1) When flaring is carried out for R410A using the conventional flare tools, adjustment of projection margin is necessary. For this adjustment, a copper pipe gauge, etc. are necessary.

(Note 2) Charging cylinder for R410A is being currently developed.

General tools (Conventional tools can be used.)

In addition to the above exclusive tools, the following equipments which serve also for R22 are necessary as the general tools.

- 1) Vacuum pump
Use vacuum pump by attaching vacuum pump adapter.
- 2) Torque wrench
- 3) Pipe cutter
- 4) Reamer
- 5) Pipe bender
- 6) Level vial
- 7) Screwdriver (+, -)
- 8) Spanner or Monkey wrench
- 9) Hole core drill
- 10) Hexagon wrench (Opposite side 4mm)
- 11) Tape measure
- 12) Metal saw

Also prepare the following equipments for other installation method and run check.

- 1) Clamp meter
- 2) Thermometer
- 3) Insulation resistance tester
- 4) Electro-scope

2. SPECIFICATIONS

2-1. Indoor Unit

50Hz

Model name		MML-	AP0074NH	AP0094NH	AP0124NH	AP0154NH	AP0184NH
Cooling / Heating capacity (Note 1)		(kW)	2.2/2.5	2.8/3.2	3.6/4.0	4.5/5.0	5.6/6.3
Electrical Characteristics	Pewer Spply	1 Phase 50Hz 230V (220-240V) (Separate power supply for indoor units is required.)					
	Running current	(A)	0.20	0.20	0.23	0.29	0.42
	Pewer consumption	(kW)	0.021	0.021	0.025	0.034	0.052
	Starting current	(A)	0.26	0.26	0.30	0.38	0.55
Appearance	Suction grille and side panel	Moon white					
	Discharge-grille	Moon white					
	Bottom surface	Moon white					
Dimension	Height	(mm)	600				
	Width	(mm)	700				
	Depth	(mm)	220				
Total weight		(kg)	17				
Heat exchanger		Finned tube					
Soundproof / Heat-insulating material		Formed polystyrene , Polyetyrene					
Fan unit	Fan	Turbo fan					
	Standard air flow (High/Mid/Low)	(m ³ /h)	510/366/282	510/366/282	552/408/324	624/468/384	726/528/426
	Motor outlet	(W)	41				
Air filter		Standard filter attached					
Controller		Wireless remote controller (packed with indoor unit)					
Conecting pipe	Gas side	(mm)	Φ 9.5			Φ 12.7	
	Liquid side	(mm)	Φ 6.4				
	Drain port (Normal dia.)	16 (Polypropylene tube)					
Sound pressure level (Note 2) (High/Mid/Low)		(dB(A))	38/32/26	38/32/26	40/34/29	43/37/31	47/40/34
PMV Kit		Available					

Note 1 : The cooling capacities and electrical characteristics are measured under the conditions specified by JIS B 8615 based on the reference piping.

The reference piping consists of 5m of main piping and 2.5m of branch piping connected with 0 meter height..

Note 2 : The sound level are mesured in an anechoic chamber in accordance with JIS B 8616.

Nomally, The values measured in the actual operating environment become larger tan the indicated values due to the effects of external sound..

Note : Rated conditions Cooling : Indoor air temperature 27°C DB/19°CWB, Outdoor air temperature 35°C DB

Heating : Indoor air temperature 20°C DB, Outdoor air temperature 7°C DB/6°C WB

Model name		MML-	AP0074NH	AP0094NH	AP0124NH	AP0154NH	AP0184NH
Cooling / Heating capacity (Note 1)		(kW)	2.2/2.5	2.8/3.2	3.6/4.0	4.5/5.0	5.6/6.3
Electrical Characteristics	Power Sply		1 Phase 60Hz 220V (Separate power supply for indoor units is required.)				
	Running current	(A)	0.17	0.17	0.19	0.25	0.36
	Power consumption	(kW)	0.021	0.021	0.025	0.034	0.052
	Starting current	(A)	0.22	0.22	0.25	0.33	0.47
Appearance	Suction grille and side panel		Moon white				
	Discharge-grille		Moon white				
	Bottom surface		Moon white				
Dimension	Height	(mm)	600				
	Width	(mm)	700				
	Depth	(mm)	220				
Total weight		(kg)	17				
Heat exchanger			Finned tube				
Soundproof / Heat-insulating material			Formed polystyrene , Polyetyrene				
Fan unit	Fan		Turbo fan				
	Standard air flow (High/Mid/Low)	(m ³ /h)	510/366/282	510/366/282	552/408/324	624/468/384	726/528/426
	Motor outlet	(W)	41				
Air filter			Standard filter attached				
Controller			Wireless remote controller (packed with indoor unit)				
Conecting pipe	Gas side	(mm)	Φ 9.5			Φ 12.7	
	Liquid side	(mm)	Φ 6.4				
	Drain port (Normal dia.)		16 (Polypropylene tube)				
Sound pressure level (Note 2) (High/Mid/Low)		(dB(A))	38/32/26	38/32/26	40/34/29	43/37/31	47/40/34
PMV Kit			Available				

Note 1 : The cooling capacities and electrical characteristics are measured under the conditions specified by JIS B 8615 based on the reference piping.

The reference piping consists of 5m of main piping and 2.5m of branch piping connected with 0 meter height..

Note 2 : The sound level are mesured in an anechoic chamber in accordance with JIS B 8616.

Nomally, The values measured in the actual operating environment become larger tan the indicated values due to the effects of external sound..

Note : Rated conditions Cooling : Indoor air temperature 27°C DB/19°CWB, Outdoor air temperature 35°C DB

Heating : Indoor air temperature 20°C DB, Outdoor air temperature 7°C DB/6°C WB

3. CONSTRUCTION VIEWS (EXTERNAL VIEWS)

Indoor Unit

MML-AP0074NH-E, -TR
 MML-AP0094NH-E, -TR
 MML-AP0124NH-E, -TR
 MML-AP0154NH-E, -TR
 MML-AP0184NH-E, -TR

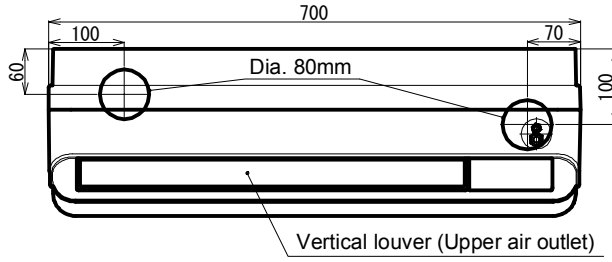

Connecting pipe

MML-	AP0074 to AP0124 type	AP0154 to AP0184 type
Liquid side	dia. 6.35	dia. 6.35
Gas side	dia. 9.52	dia. 12.7

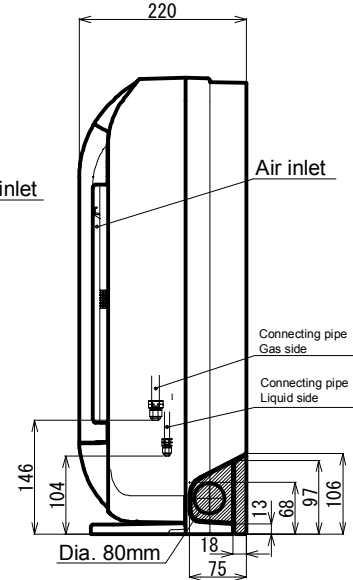
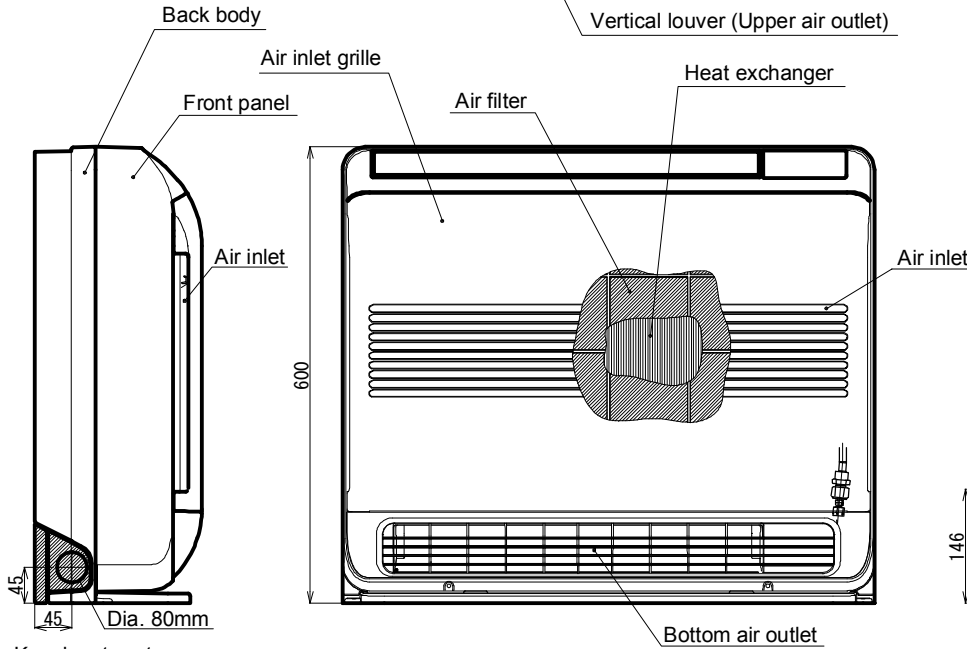

Knock out system

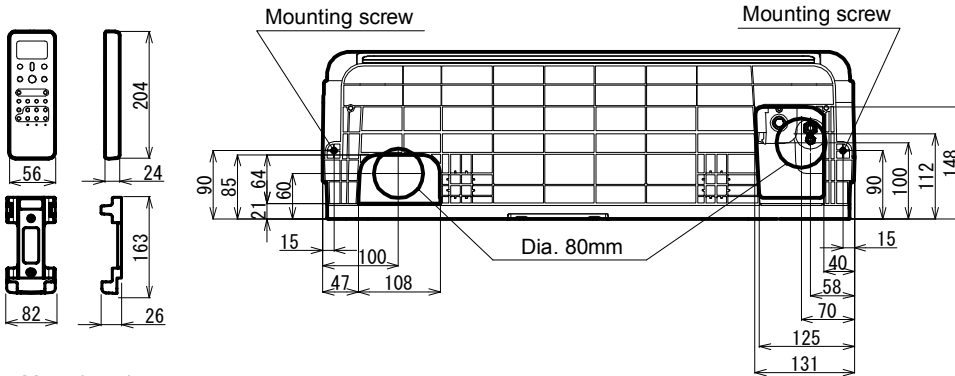

Space required for installation and servicing

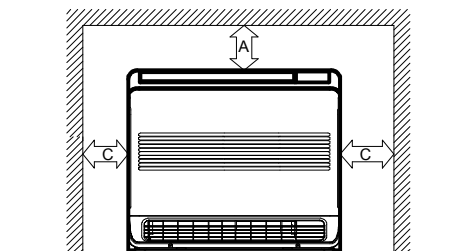

Distance	
A	300 or more
B	300 or more
C	300 or more

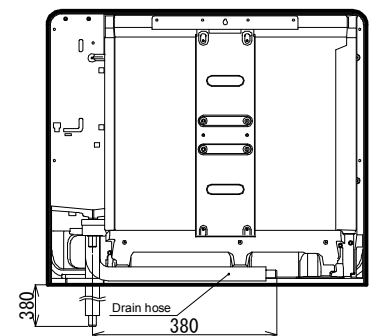
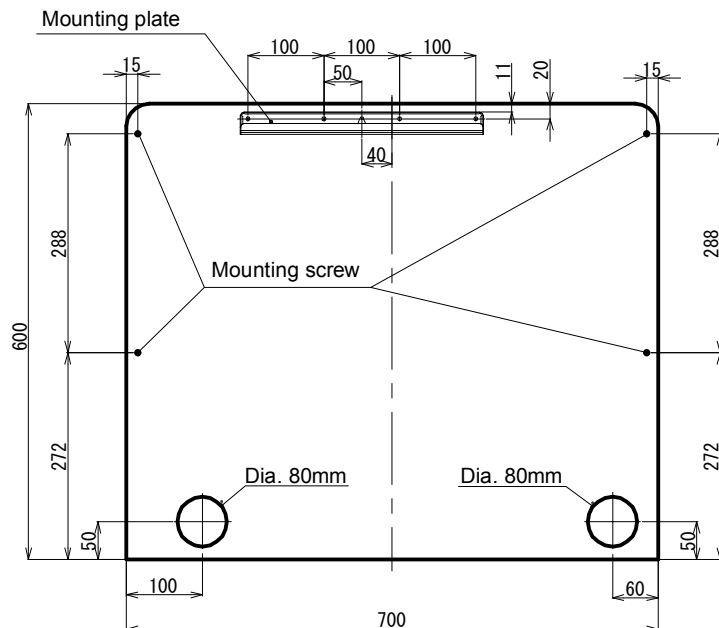

Back side View

Front View

4. WIRING DIAGRAM

Model: MML-AP0074NH-E, -TR, MML-AP0094NH-E, -TR, MML-AP0124NH-E, -TR
 MML-AP0154NH-E, -TR, MML-AP0184NH-E, -TR

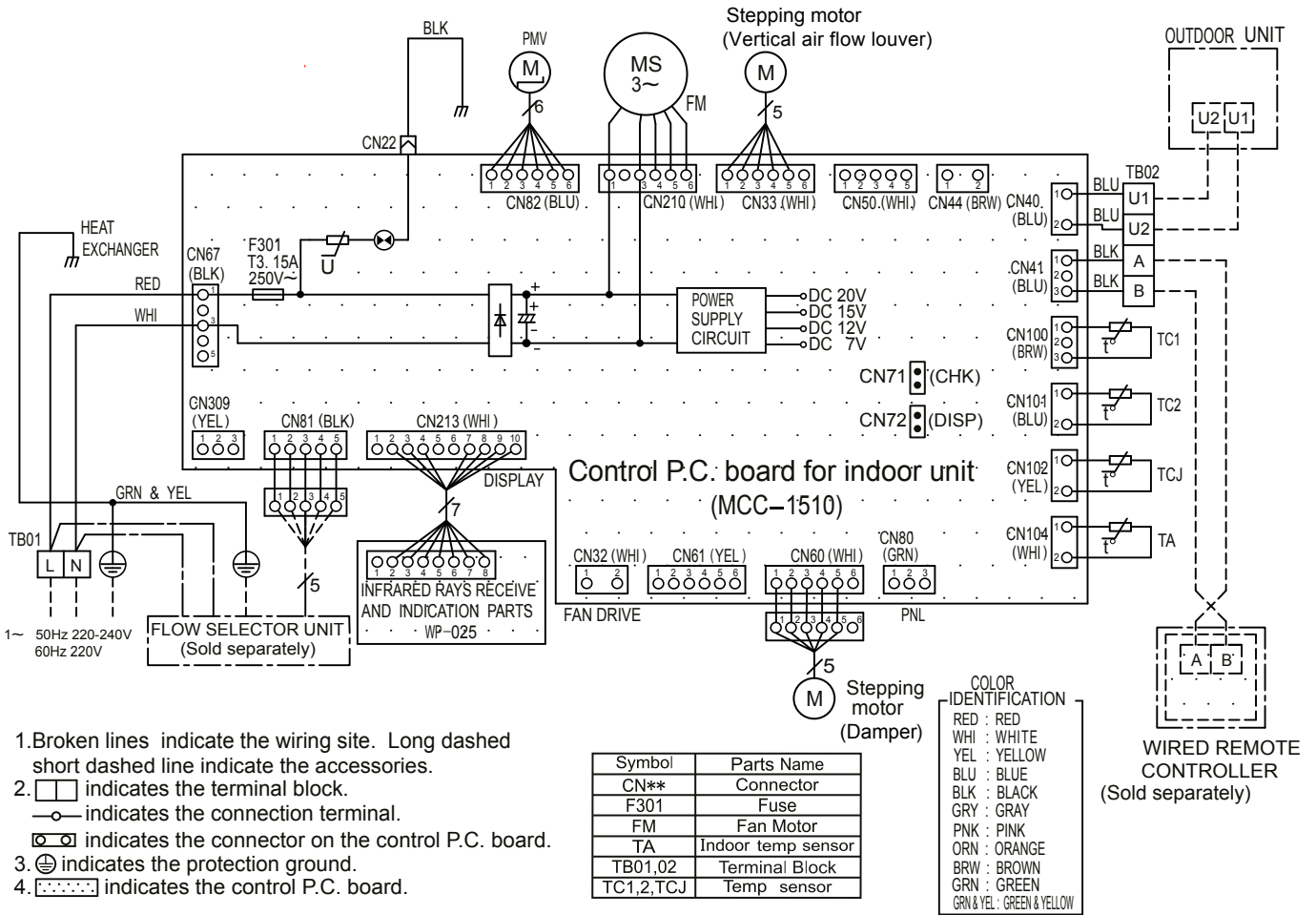

1. Broken lines indicate the wiring site. Long dashed short dashed line indicate the accessories.
2. indicates the terminal block.
 indicates the connection terminal.
 indicates the connector on the control P.C. board.
3. indicates the protection ground.
4. indicates the control P.C. board.

5. PARTS RATING

5-1. Parts Rating

No.	Parts Name	Type	Specifications
1	Fan motor (for indoor)	ICF-340-41-1	Output (Rated) 41W, 340V DC
2	Louver motor	MP24Z3T	Output (Rated) 1W, 16 poles DC
3	Damper motor	MP24Z3T	Output (Rated) 1W, 16 poles DC
4	Thermo. Sensor (TA sensor)	268mm	10kΩ at 25°C
5	Heat exchanger sensor (TC1 sensor)	Ø4.6mm	10kΩ at 25°C
6	Heat exchanger sensor (TC2 sensor)	Ø6.8mm	10kΩ at 25°C
7	Heat exchanger sensor (TCJ sensor)	Ø6.8mm	10kΩ at 25°C
8	PMV motor	EFM-MD12TCTH-1	12V DC

5-2. Name of Each Part

Model : MML-APXXX4NH series

Upper air outlet grille/Louver

Change the direction of the air to be discharged according to cool/heat mode.

Air inlet grille

Air in the room is sucked from here.

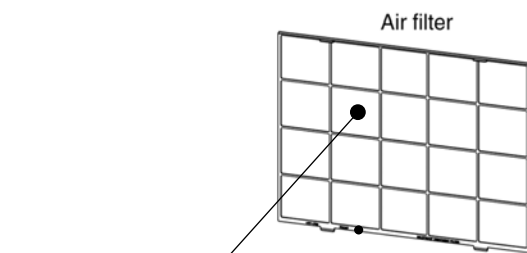

Air filter

Removes dirt or dust.
(Provided in the air inlet grille)

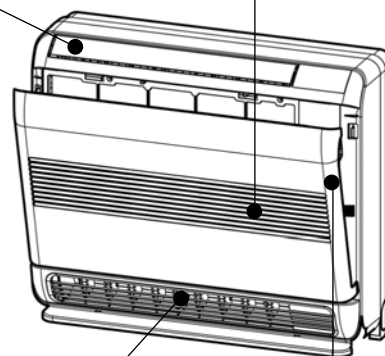

Lower air outlet grille/Damper

Earth screw

Earth screws are provided in the electric parts box.

5-3. Parts Name of Remote Controller

■ Display section

In the display example, all indicators are displayed for the explanation. In reality only, the selected contents are indicated.

- When turning on the main power switch and leak breaker at the first time, **SETTING** flashes on the display part of the remote controller.
- While this display is flashing, the model is being automatically confirmed.

Accordingly, wait for a while after **SETTING** display has disappeared, and then use the remote controller.

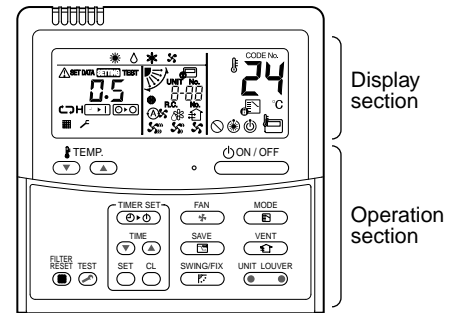

This remote controller can control the operation of Max. 8 indoor units.

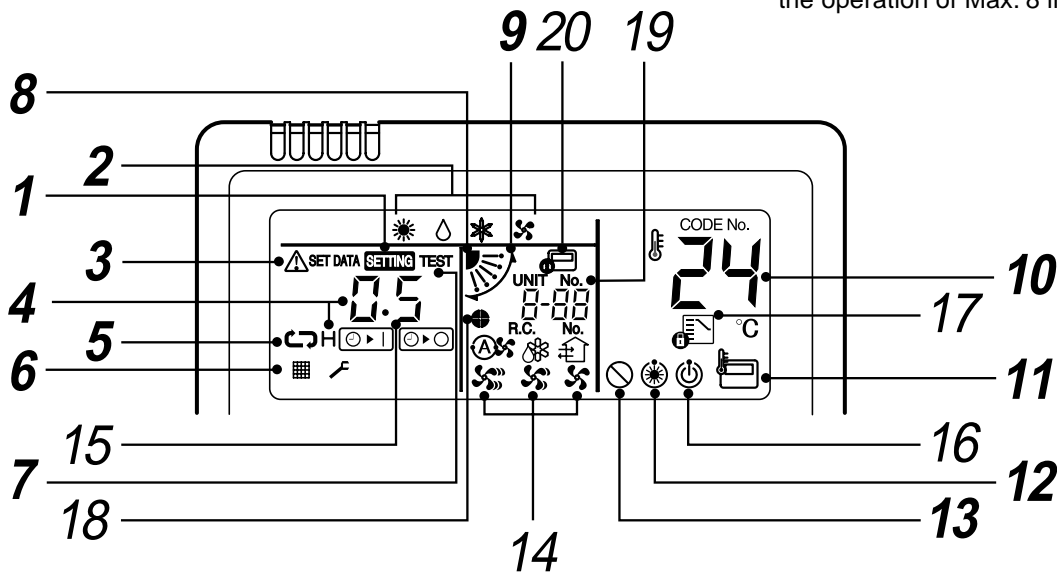

1 SETTING display

Displayed during setup of the timer etc.

2 Operation mode select display

The selected operation mode is displayed.

3 CHECK display

Displayed while the protective device works or a trouble occurs.

4 Timer time display

Time of the timer with H mark is displayed. (When a trouble occurs, the check code is displayed.)

5 Timer SET IN setup display

When pushing the Timer SET IN button, the display of the timer is selected in order of [OFF] → [OFF] repeat OFF timer → [ON] → No display.

6 Filter display

If "FILTER " is displayed, clean the air filter.

7 TEST run display

Displayed during a test run.

8 Louver position display

(4-way Air Discharge Cassette, 2-way Air Discharge Cassette, 1-way Air Discharge Cassette, Under Ceiling, High Wall Type only (2H, 3H)) and Console
Displays louver position.

9 SWING display

Displayed during up/down movement of the louver.

10 Set up temperature display

The selected set up temp. is displayed.

11 Remote controller sensor display

Displayed while the sensor of the remote controller is used.

12 PRE-HEAT display (Heat-pump model only)

Displayed when the heating operation starts or defrost operation is carried out.

While this indication is displayed, the indoor fan stops or the mode enters in LOW.

13 No function display

Displayed if there is no function even if the button is pushed.

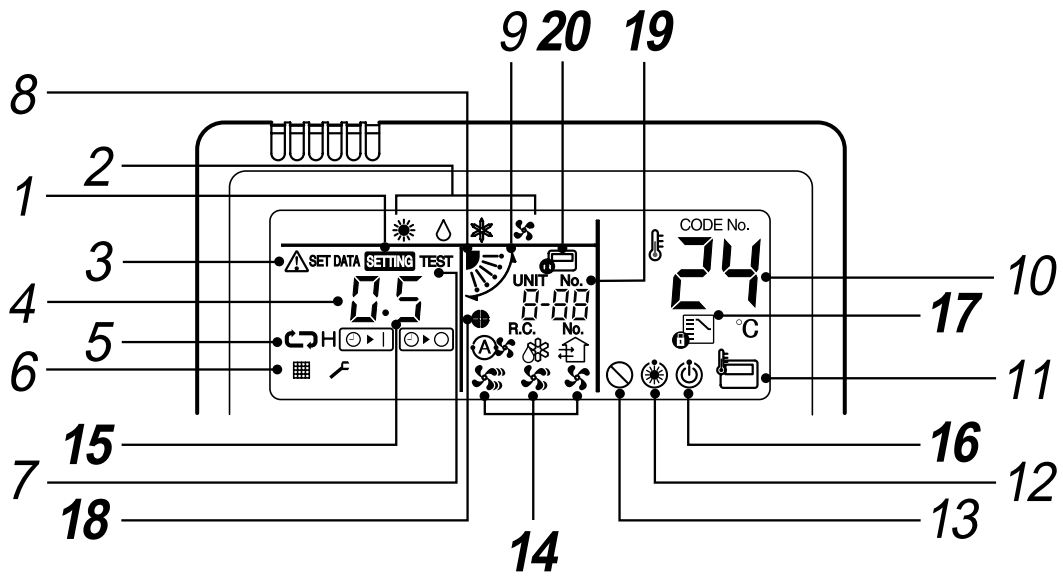

14 Air volume select display

The selected air volume mode is displayed.

(AUTO)		(HIGH)	
(MED.)		(LOW)	

15 Louver Number display (example: 01, 02, 03, 04)

16 Operation ready display

Displayed when cooling or heating operation is impossible because the outdoor temperature goes out of the operable range.

17 Mode select control display

Displayed when pushing "Operation mode select" button while the operation mode is fixed to heating or cooling by the system manager of the air conditioner.

18 Louver lock display (4-way Air Discharge Cassette Type 2H series only)

Displayed when there is a louver-locked unit in the group (including 1 indoor unit by 1 outdoor unit).

19 Unit Number display

Unit number of the indoor unit selected with the unit select button or abnormal indication of the indoor/outdoor unit.

20 Central control display

Displayed when the air conditioner is used under the central control in combination with a central control remote controller.

In case the remote controller is disabled by the central control system, flashes.

The button operation is not accepted.

Even when you push ON/OFF, MODE, or TEMP. button, the button operation is not accepted.

(Settings made by the remote controller vary with the central control mode.

For details, refer to the Owner's Manual of the central control remote controller.)

■ Operation section

Push each button to select a desired operation.

- The details of the operation needs to be set up once, afterward, the air conditioner can be used by pushing  button only.

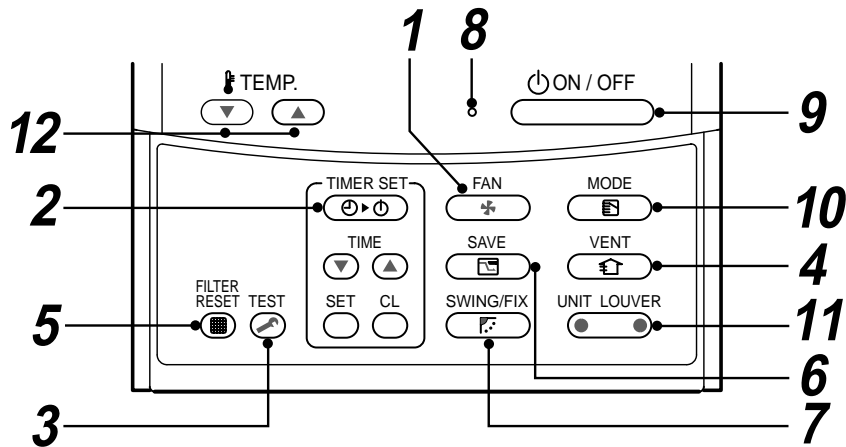

1 button (Air volume select button)

Selects the desired air volume mode.

2 button (Timer set button)

TIMER SET button is used when the timer is set up.

3 button (Check button)

The CHECK button is used for the check operation. During normal operation, do not use this button.

4 button (Ventilation button)

Ventilation button is used when a fan which is sold on the market is connected.

- If “No function  button, a fan is not connected.

5 button (Filter reset button)

Resets (Erases) “ FILTER” display.

6 button (Power save operation)

No function

7 button (Swing/Wind direction button)

Selects automatic swing or setting the louver direction.

- This function is not provided to
Concealed Duct Standard Type,
High Static Pressure Type,
Floor Standing Cabinet Type,
Floor Standing Concealed Type or Slim Duct Type.

8 Operation lamp

Lamp is lit during the operation.

Lamp is off when stopped.

Also it flashes when operating the protection device or abnormal time.

9 button

When the button is pushed, the operation starts, and it stops by pushing the button again. When the operation has stopped, the operation lamp and all the displays disappear.

10 button (Operation mode select button)

Selects desired operation mode.

11 button (Unit/Louver select button)

Selects a unit number (left) and louver number (right).

UNIT:



Selects an indoor unit when adjusting wind direction when multiple indoor units are controlled with one remote controller.

LOUVER (4-way Air Discharge Cassette Type 2H series only):

Selects a louver when setting louver lock or wind direction adjustment independently.

12 button (Set up temperature button)

Adjusts the room temperature.

Set the desired set temperature by pushing  TEMP. .

OPTION :

Remote controller sensor

Usually the TEMP. sensor of the indoor unit senses the temperature. The temperature on the surrounding of the remote controller can also be sensed. For details, contact the dealer from which you have purchased the air conditioner.

- In case that one remote controller controls the multiple indoor units, the setup operation is unavailable in group control.

5-4. Correct Usage

- When you use the air conditioner for the first time or when you change the SET DATA value, follow the procedure below.

From the next time, the operation displayed on the remote controller will start by pushing the  button only.

■ Preparation

Turn on the main power switch and/or the leakage breaker.

- When the power supply is turned on, a partition line is displayed on the display part of the remote controller.
- * After the power supply is turned on, the remote controller does not accept an operation for approx. 1 minute, but it is not a failure.

REQUIREMENT

- While using the air conditioner, operate it only with  button without turning off the main power switch and the leak breaker.
- When you use the air conditioner after it has not been used for a long period, turn on the power switch at least 12 hours before starting operation.

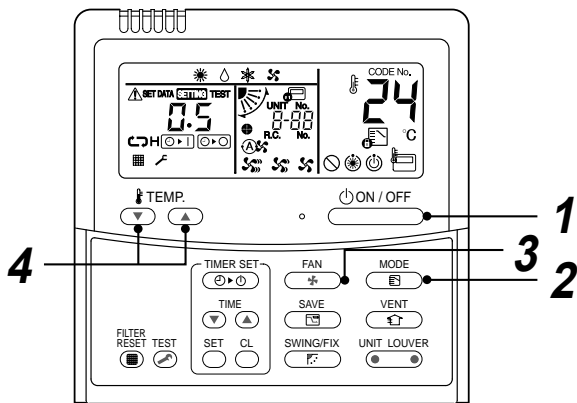

3 Select air volume with “ ” button.

One push of the button, and the display changes in the order shown as follows.

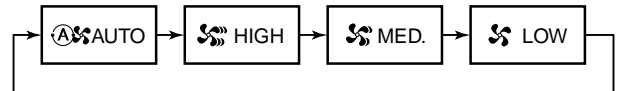

Start

1 Push button.







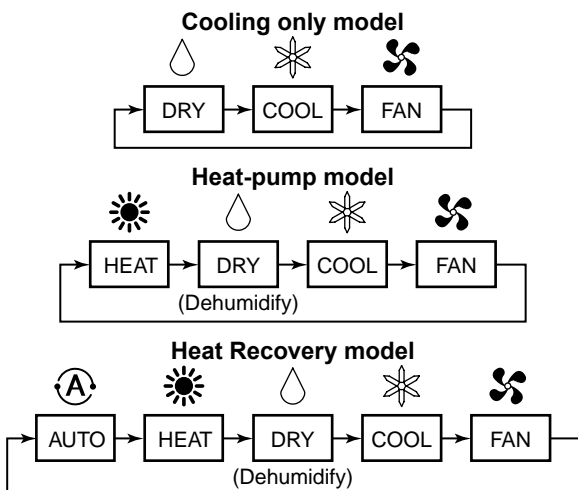

The operation lamp goes on, and the operation starts.

2 Select an operation mode with the “MODE ” button.

One push of the button, and the display changes in the order shown as follows.

- “  DRY mode” function is not provided to Concealed Duct High Static Pressure Type.



- When air volume is “  AUTO”, air volume differs according to the room temperature.
- In  DRY mode, “  AUTO” is displayed and the air volume is LOW.
- In heating operation, if the room temperature is not heated sufficiently with VOLUME “  LOW” operation, select “  MED.” or “  HIGH” operation.
- The temperature sensor senses temperature near the air inlet of the indoor unit, which differs from the room temperature depending on the installation condition.
- A value of setting temperature is the measure of room temperature. (“  AUTO” is not selectable in the FAN mode.)
- Air volume of function is not provided to “Concealed Duct High Static Pressure Type” but air speed “  HIGH” only is displayed.

4 Determine the set up temperature by pushing the “TEMP. ” or “TEMP. ” button.

Stop

Push button.

The operation lamp goes off, and the operation stops.

[In case of cooling]

- Start the cooling operation after approx. 1 minute.

[In case of heating (For Heat-pump model only)]

- The heating operation mode is selected in accordance with the room temperature and operation starts after approximately 3 to 5 minutes.
- After the heating operation has stopped, FAN operation may continue for approx. 30 seconds.
- When the room temperature reaches the set temperature, the super low wind is discharged and the air volume decreases excessively.
- During defrost operation, the fan stops so that cool air is not discharged. (“ PRE-HEAT” is displayed.)

NOTE

When restarting the operation after stop

- When restarting the operation immediately after stop, the air conditioner does not operate for approx. 3 minutes to protect the machine.
-

Automatic Operation (Super Heat Recovery Type Only)

When you set the air conditioner in  mode or switch over from AUTO operation because of some settings change, it will automatically select either cooling, heating, or fan only operation depending on the indoor temperature.

5-5. Adjustment of Wind Direction

For best cooling and heating performance, adjust the louvers (adjustment of up/down wind direction) appropriately.

CAUTION

- If cooling operation is performed with downward air outlet, dew may fall on surface of the cabinet or the horizontal louver resulted in dripping.
 - If heating operation is performed with horizontal air outlet, unevenness of temperature may increase in the room.
 - Do not move the horizontal louver directly with hands; otherwise a trouble is caused.
Select direction of the horizontal louver using  switch on the remote controller.
The horizontal louver does not stop immediately even if the switch is pushed.
Adjusting the stop position, push the switch.
-

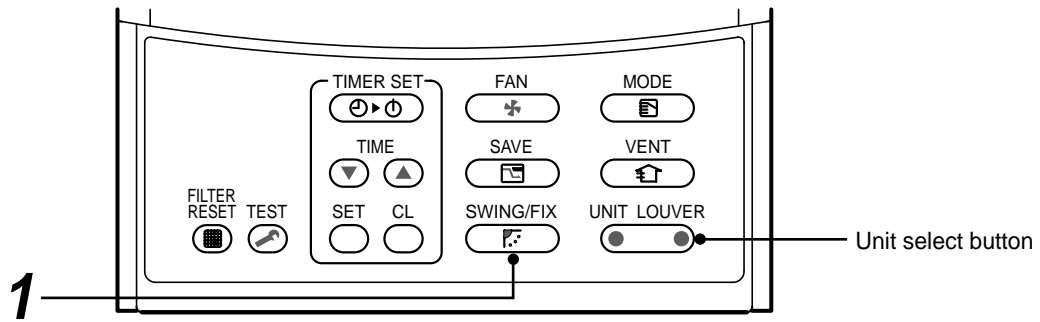

■ How to set up the wind direction

1 Push during operation.

The wind direction changes for every push of the button.

[In HEAT operation]

Direct the louver (adjustment plate of up/down wind direction) downward.

If directing horizontally, hot air may not come to the foot.

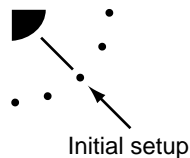

[In COOL/DRY operation]

Direct the louver (adjustment plate of up/down wind direction) horizontally.

If directing it downward, the dew may form on the surface of the air discharge port and may drop down.

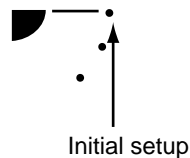

[In FAN operation]

Select a desired wind direction.

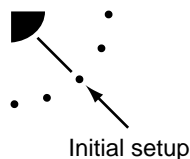

■ How to start swinging

1 Push , set the louver (adjustment plate of up/down wind direction) direction to the lowest position, and then push again.

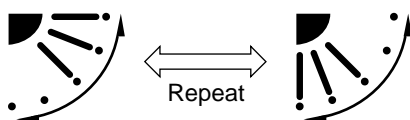

SWING  is displayed and the up/down wind direction is automatically selected.

Display during swinging



■ How to stop swinging

1 Push at a desired position while the louver is swinging.

- When  is pushed after that, wind direction can be set again from the highest position.
- * However, even if  is pushed while the louver is swinging, the louver position is displayed as follows and highest position of the louver may not be selected.

Display when swinging is stopped





In this case, push  again two seconds later.

- In COOL/DRY operation, the louver does not stop as it directs downward. If stopping the louver as it directs downward during swing operation, it stops after moving to the third position from the highest position.

Display when stopping the swing



Unit select button

- When multiple indoor units are controlled with one remote controller, wind direction can be set for each indoor unit by selecting individually.
- To set wind direction individually, push  button to display an indoor unit number in the control group. Then set the wind direction of the displayed indoor unit.
- When no indoor unit number is displayed, all indoor units in the control group can be controlled simultaneously.
- Each time you push  button, the display changes as follows:

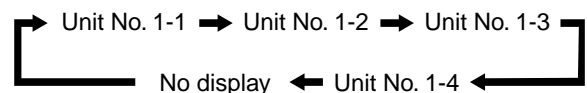

■ Adjusting airflow direction

- Adjust the airflow direction properly. Otherwise, it might cause discomfort and make the room temperature uneven.
- Adjust the vertical airflow using the remote controller.
- Adjust the horizontal airflow manually.

Adjust the vertical airflow

The air conditioner automatically adjusts the vertical airflow direction in accordance with the operating conditions when AUTO or A mode is selected.

To set the airflow direction you desire

Perform this function when the air conditioner is in operation.

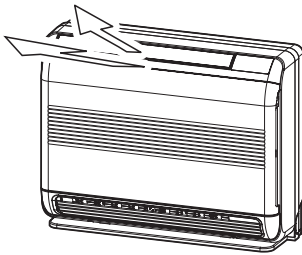

NOTE

- Operating angle of vertical airflow louver will be different during cooling, dry and heating operation.
- Concerning airflow from the lower air outlet grille. In the cooling operation, airflow is blown out only from the upper air outlet grille under some operating conditions. In the dry operation, airflow is blown out only from the upper air outlet grille.

To automatically swing the airflow direction

Perform this function when the air conditioner is in operation.

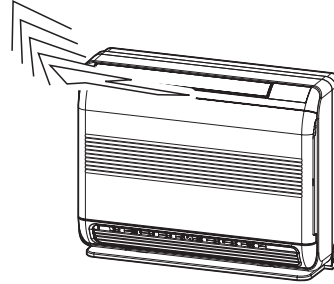

! CAUTION

- The FIX and SWING buttons will be disabled when the air conditioner is not in operation (including when the ON timer is set).
- Do not operate the air conditioner for long hours with the airflow direction set downward during the cooling or dry operation. Otherwise, condensation may occur on the surface of the vertical airflow louver and cause dew dripping.
- Do not move the vertical airflow louver manually. Always use the FIX button. If you move the louver manually, it may malfunction during operation. If the louver malfunctions, stop the air conditioner once, and restart.
- When the air conditioner is started immediately after it was stopped, the vertical airflow louver might not move for 10 seconds or so.
- Louver operation is limited when performing group control. (see page 12)

Air flow from the lower air outlet grille (Damper control)

Damper is moved (to OPEN or to CLOSED) automatically.

In the COOLING operation, Damper is determined according to room temperature and running time.

In the DRY operation, damper is closed.

In the HEATING operation, damper is open.

Operation	COOLING		DRY	HEATING		
Running time	less than 1 H		-	-		
Room temperature	$T_a \geq T_{sc} + 2^\circ\text{C}$	$T_a < T_{sc} + 2^\circ\text{C}$	-	-		
Airflow	Bi Flow 	Upper Flow 	Upper Flow 	Upper Flow 	Bi Flow 	(When is selected) Lower Flow
Damper	OPEN	CLOSED	CLOSED	OPEN		

When [Hi POWER] is selected with wireless remote controller, running time is cleared once.

■ Adjust the horizontal airflow

Preparation

- Take hold of the lever on the horizontal airflow louver and move them to adjust the airflow direction as required.
- You can adjust the airflow at the left, and right locations of the louver.

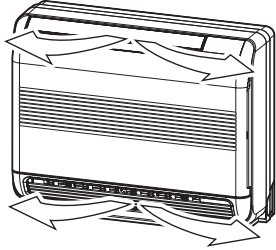

5-6. Timer Operation

- A type of timer operation can be selected from the following three types. (Setting of up to 168 hours is enabled.)
 - OFF timer : The operation stops when the time of timer has reached the set time.
 - Repeat OFF timer : Every time, the operation stops after the set time has passed.
 - ON timer : The operation starts when the time of timer has reached the set time.

■ Timer operation

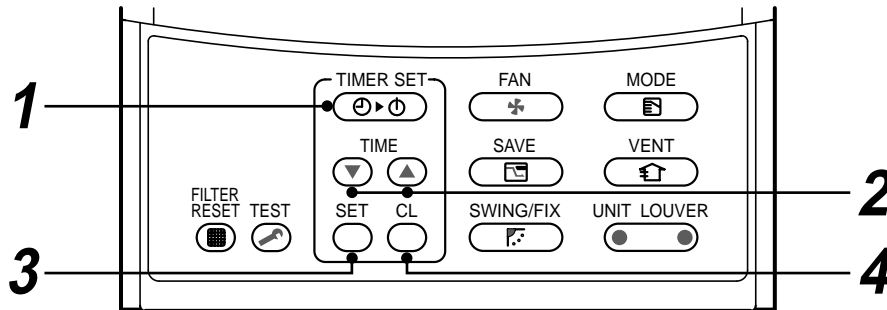

Set

1 Push TIMER SET button.

The timer display (type) changes for every push of the button.

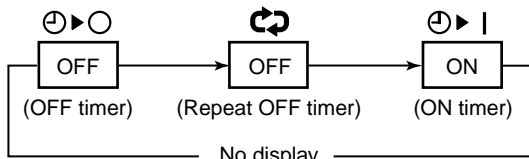

- SETTING** and timer time displays flash.

2 Push **TIME** to select "SET TIME".

- For every push of **▲** button, the set time increases in the unit of 0.5 hr (30 minutes). When setting a time more than 24 hours for timer operation, timer time can be set in the unit of 1 hr. The maximum set time is 168hr (7 days). The remote controller displays the set time with time (between 0.5 and 23.5 hours) (*1) or number of days and time (24 hours or more) (*2) as shown below.
- For every push of **▼** button, the set time decreases in the unit of 0.5 hr (30 minutes) (0.5 to 23.5 hours) or 1 hr (24 to 168 hours).

Example of remote controller display

- In the case of 23.5 hours (*1)



- In the case of 34 hours (*2)

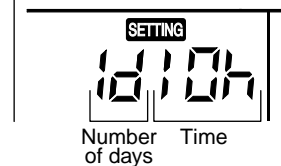

1d shows 1 day (24 hours).

10h shows 10 hours. (Total 34 hours).

3 Push SET button.

- SETTING** display disappears and timer time display goes on, and **▶** or **◻** display flashes. (When ON timer is activated, timer time, ON timer **▶** are displayed and other displays disappear.)

4 Cancel of timer operation

Push **CL** button.

TIMER display disappears.

NOTE

- When the operation stops after the timer reached the preset time, the Repeat OFF timer resumes the operation by pushing **ON/OFF** button and stops the operation after the reached the set time.
- When you push **SWING/FIX** while the OFF timer function of the air conditioner is active, the indication of the timer function disappears and then appears again after about 5 seconds.

This is due to normal processing of the remote controller.

5-7. Installation

Installation place



-
- Check that the air conditioner is not installed in a place subject to combustible gas leak. Accumulation of combustible gas around the unit may cause a fire.
 - Drain the dehumidified water from the indoor unit and outdoor unit to a well-drained place.
 - Do not put any obstacle near the air inlets and air outlet of the outdoor unit. Doing so may hinder the radiation, which may reduce the performance or activate the protective device.
-

Electrical wiring



-
- Be sure to connect earth wire. (grounding work) Incomplete grounding cause an electric shock. Do not connect ground wires to gas pipes, water pipes, lightning rods or ground wires for telephone wires.
-



-
- **Make sure that a leakage breaker is connected.**
Using the air conditioner without leakage breaker may cause electric shock.
 - **Use a leakage breaker with an appropriate capacity.**
Be sure to use the rated voltage and an exclusive circuit for power supply of the air conditioner.
-

Do not install the air conditioner in the following places

- Do not install the air conditioner in any place within 1 m from a TV, stereo, or radio set. If the unit is installed in such place, noise transmitted from the air conditioner affects the operation of these appliances.
- Do not install the air conditioner near a high frequency appliance (sewing machine or massager for business use, etc.), otherwise the air conditioner may malfunction.
- Do not install the air conditioner in a humid or oily place, or in a place where steam, soot, or corrosive gas is generated.
- Do not install the air conditioner in a salty place such as seaside area.
- Do not install the air conditioner in a place where a great deal of machine oil is used.
- Do not install the air conditioner in a place where it is usually exposed to strong wind such as in seaside area.
- Do not install the air conditioner in a place where sulfurous gas generated such as in a spa.
- Do not install the air conditioner in a vessel or mobile crane.
- Do not install the air conditioner in an acidic or alkaline atmosphere (in a hot-spring area or near a chemicals factory, or in a place subject to combustion emissions). Corrosion may be generated on the aluminum fin and copper pipe of the heat exchanger.
- Do not install the air conditioner near an obstacle (air vent, lighting equipment, etc.) that disturbs discharge air. (Turbulent airflow may reduce the performance or disable devices.)
- Do not use the air conditioner for special purposes such as preserving food, precision instruments, or art objects, or where breeding animals or growing plants are kept. (This may degrade the quality of preserved materials.)
- Do not install the air conditioner over an object that must not get wet. (Condensation may drop from the indoor unit at a humidity of 80% or more or when the drain port is clogged.)
- Do not install the air conditioner in a place where an organic solvent is used.
- Do not install the air conditioner near a door or window subject to humid outside air. Condensation may form on the air conditioner.
- Do not install the air conditioner in a place where special spray is used frequently.

Be careful with noise or vibrations

- Do not install the air conditioner in a place where noise by outdoor unit or hot air from its air outlet annoys your neighbors.
- Install the air conditioner on a solid and stable foundation so that it prevents transmission of resonating, operation noise and vibration.
- If one indoor unit is operating, some sound may be audible from other indoor units that are not operating.

5-8. Maintenance

WARNING



Be sure to turn off the main power switch prior to the maintenance.

- Please do not intend to do the daily maintenance and/or Air Filter cleaning by yourself.

Cleaning of the air filter and other parts of the air filter involves dangerous work in high places, so be sure to have a service person do it. Do not attempt it yourself.

Cleaning of air filters

Clogging of air filters will reduce the cooling and heating performance.

- 1 When “ FILTER” appears on the remote controller, clean the air filters.
- 2 When the cleaning of air filters has been completed, push  button. “ FILTER” disappears.

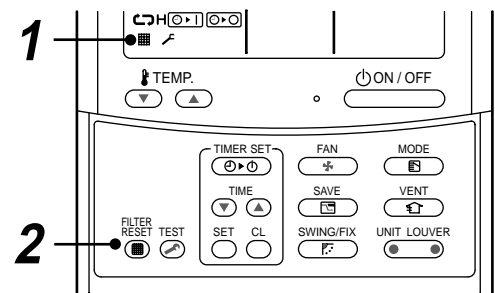

CAUTION

Cleaning of unit

Clean the unit with a soft dry cloth.

If dirt cannot be removed with the dry cloth, use a cloth slightly dampened with lukewarm (under 40 °C) water.

Cleaning of remote controller

- Use a dry cloth to wipe the remote controller.
- A cloth dampened with cold water may be used on the indoor unit if it is very dirty.
- Never use a damp cloth on the remote controller.
- Do not use a chemically-treated duster for wiping or leave such materials on the unit for long. It may damage or fade the surface of the unit.
- Do not use benzine, thinner, polishing powder, or similar solvents for cleaning. These may cause the plastic surface to crack or deform.

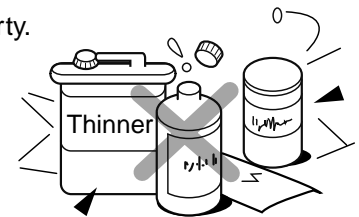

Periodic check

Long-period use of the air conditioner may cause deterioration or failure of parts due to heat, humidity, dust, and operating conditions, or may cause poor drainage of dehumidified water.

If you do not plan to use the unit for more than 1 month

- 1) Operate the fan for 3 to 4 hours to dry inside the unit.
 - Operate “FAN” mode.
- 2) Stop the air conditioner and turn off the main power switch or the circuit breaker.

Checks before operation

- 1) Check that the air filters are installed.
- 2) Check that the air outlet or inlet is not blocked.
- 3) Turn on the main power switch or the circuit breaker for the main power supply to the air conditioner.

NOTE

- For environmental conservation, it is strongly recommended that the indoor and outdoor units of the air conditioner in use be cleaned and maintained regularly to ensure efficient operation of the air conditioner. When the air conditioner is operated for a long time, periodic maintenance (once a year) is recommended. Furthermore, regularly check the outdoor unit for rust and scratches, and remove them or apply rustproof treatment, if necessary.

As a general rule, when an indoor unit is operated for 8 hours or more daily, clean the indoor unit and outdoor unit at least once every 3 months. Ask a professional for this cleaning/maintenance work.

Such maintenance can extend the life of the product though it involves the owner's expense.

Failure to clean the indoor and outdoor units regularly will result in poor performance, freezing, water leakage, and even compressor failure.

Maintenance List

Part	Check (visual/auditory)	Maintenance
Heat exchanger	<ul style="list-style-type: none">• Dust/dirt clogging, scratches	<ul style="list-style-type: none">• Wash the heat exchanger when it is clogged.
Fan motor	<ul style="list-style-type: none">• Sound	<ul style="list-style-type: none">• Take appropriate measures when abnormal sound is generated.
Filter	<ul style="list-style-type: none">• Dust/dirt, breakage	<ul style="list-style-type: none">• Wash the filter with water when it is contaminated.• Replace it when it is damaged.
Fan	<ul style="list-style-type: none">• Vibration, balance• Dust/dirt, appearance	<ul style="list-style-type: none">• Replace the fan when vibration or balance is terrible.• Brush or wash the fan when it is contaminated.
Air inlet/outlet grilles	<ul style="list-style-type: none">• Dust/dirt, scratches	<ul style="list-style-type: none">• Fix or replace them when they are deformed or damaged.
Drain pan	<ul style="list-style-type: none">• Dust/dirt clogging, drain contamination	<ul style="list-style-type: none">• Clean the drain pan and check the downward slope for smooth drainage.
Ornamental panel, louvers	<ul style="list-style-type: none">• Dust/dirt, scratches	<ul style="list-style-type: none">• Wash them when they are contaminated or apply repair coating.



WARNING

Re-Installation

Ask the dealer or an installation professional to re-install the air conditioner to a new place or move it to another place and to observe the following items.

If the air conditioner is inappropriately installed by yourself, it may cause electric shock or fire.



CAUTION

Be sure to clean the heat exchanger with pressurized water.

If an commercially detergent (strong alkaline or acid cleaning agent) is used, the surface treatment of the heat exchanger will be marred, which may degrade the self cleaning performance. For details, contact the dealer.

■ Cleaning the air filter

Clean the air filters every 2 weeks.
If the air filters are covered with dust, the performance of the air conditioner will deteriorate.

Clean the air filters as often as possible.

1. Open the air inlet grille by gripe at the handle then pull the air inlet grille as the arrow direction.

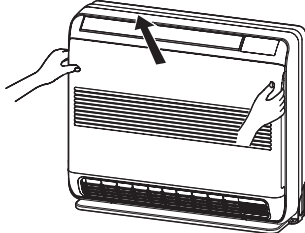

2. Take hold the left and right handles of air filter and push it down to release them from holding slot, then pull it upward to take it out.

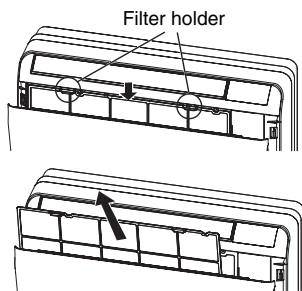

3. Use a vacuum cleaner to remove the dust from the filter or wash them with water. If you wash the air filter, dry them in the shade.

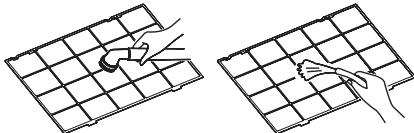

4. Insert the lower ribs of air filter into the slots then set it into the holding slot. (reverse the procedure number 2)

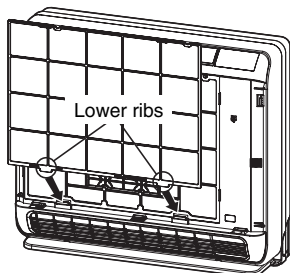

5. Close the air inlet grille.

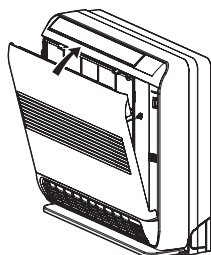

■ Cleaning the air inlet grille

1. Remove the air inlet grille by release the rope from the hook.

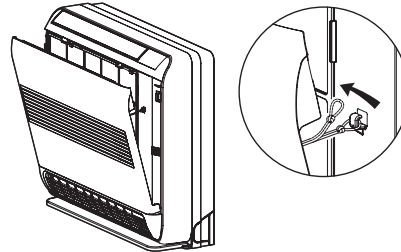

2. Wash it with water using a soft sponge or towel. (Do not use metallic scrubbing brush or the other hard brushed)
 - Use of such hard objects will cause scratches on the surface of air inlet grille.
 - If very dirty, clean the air inlet grille with a neutral detergent for kitchen use, and rinse it off with water.

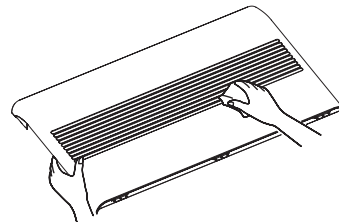

3. Wipe out water from air inlet grille and dry it.

4. Insert the lower hooks of air inlet grille into the slots.

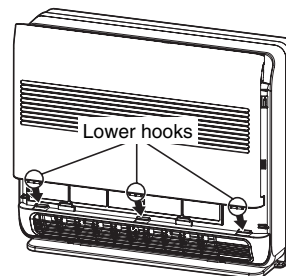

5. Hang the rope at the back side hook then close the air inlet grille.

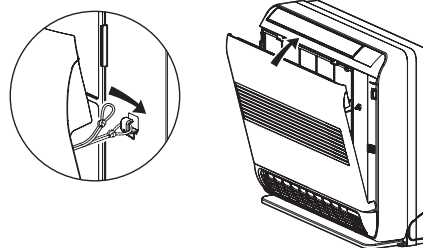

5-9. Air Conditioner Operations and Performance

Check before operation

- Check whether earth wire is disconnected or out of place.
- Check that air filter is installed to the indoor unit.
- Check that the air outlet or inlet is not blocked.
- Turn on the main power switch or the circuit breaker for the main power supply to the air conditioner.



WARNING

Turn on the power switch 12 hours or more before starting before operation.

Heating capacity (for Heat-pump model only)

- For heating, a heat pump system which sucks in outside heat air and discharges it into the room is adopted. If temperature of the outside air lowers, the heating capacity decreases.
- When temperature of the outside air is low, it is recommended to use other heating equipment together.

Defrost operation during heating operation (for Heat-pump model only)

- If the outdoor unit has some frost during heating operation, the operation mode changes automatically to defrost mode to increase the heating effect (for approx. 2 to 10 minutes).
- During defrost operation, fans of the indoor and the outdoor units stop.

3 minutes protection

- The outdoor unit does not operate for approx. 3 minutes after air conditioner has been immediately restarted after stop, or power switch has been turned on. This is to protect the system.

Main power failure

- If a power failure occurred during the operation, all operations stop.
- When restarting the operation, push ON/OFF button again.

Fan rotation of stopped unit

- While other indoor units operate, the fan on indoor units on "stand-by" rotates to protect the machine once per approx. 1 hour for several minutes.

Protective device (High pressure switch)

The high pressure switch stops the air conditioner automatically when excessive load is applied to the air conditioner. If the protective device works, the operation lamp keeps lit but the operation stops. When the protective device works, "▲" in the remote controller display part flash. The protective device may work in the following cases.

<Cooling operation>

- When the air inlet or air outlet of the outdoor unit is blocked.
- When strong wind blows continuously against the air outlet of the outdoor unit.

<Heating operation>

- When dust or dirt is excessively adhered to air filter of the indoor unit.
- When the air outlet of the indoor unit is blocked.

Cooling/heating operation of Modular Multi system air conditioner

- In Modular Multi system air conditioner, each indoor unit can be individually controlled. However, cooling operation and heating operation cannot be performed concurrently for the indoor units which are connected to one outdoor unit. When cooling operation and heating operation are performed concurrently, the indoor unit which is performing cooling operation stops, and "⊕" on the display is lit. The indoor unit which is performing heating operation continues operation. If the manager has fixed the setting to COOL or HEAT, other operation than set up one cannot be performed. When other operation than set up one is performed, "⊕" on the display is lit and the operation stops.

Characteristics of heating operation (for Heat-pump model only)

- Hot air is not out immediately after the operation has started. After 3 to 5 minutes (differs according to room or outside temperature) has passed and the indoor heat exchanger has been warmed up, hot air blows out.
- During operation, the outdoor unit may stop if outside temperature becomes high.
- When other outdoor unit performs heating operation while the fan is operating, the fan operation may be stopped temporarily to prevent blowing of hot air.

Air conditioner operating conditions

For proper performance, operate the air conditioner under the following temperature conditions:

Cooling operation	Outdoor temperature : -5°C to 43°C (Dry-bulb temp.)
	Room temperature : 21°C to 32°C (Dry-bulb temp.), 15°C to 24°C (Wet-bulb temp.)
	CAUTION Room relative humidity: less than 80 %. If the air conditioner operates in excess of this figure, the surface of the air conditioner may cause dewing.
Heating operation	Outdoor temperature : -15°C to 15.5°C (Wet-bulb temp.)
	Room temperature : 15°C to 28°C (Dry-bulb temp.)

If air conditioner is used outside of the above conditions, safety protection may operate.

5-10. When the Following Symptoms are Found

Check the points described below before asking repair servicing.

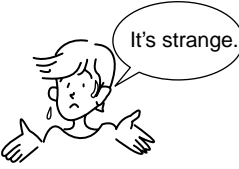
	Symptom	Cause
It is not a failure.	Outdoor unit <ul style="list-style-type: none"> • White misty cold air or water is out. • Sometimes, noise "Pushu !" is heard. 	<ul style="list-style-type: none"> • Fan of the outdoor unit stops automatically and performs defrost operation. • Solenoid valve works when defrost operation starts or finishes.
	Indoor unit <ul style="list-style-type: none"> • "Swish" sound is heard sometimes. • Slight "Pishi!" sound is heard. • Discharge air smells. • "⊕" indication is lit. • Sound or cool air is output from the stand by indoor unit. 	<ul style="list-style-type: none"> • When the operation has started, during the operation, or immediately after the operation has stopped, a sound such as water flows may be heard, and the operation sound may become larger for 2 or 3 minutes immediately after the operation has started. They are flowing sound of refrigerant or draining sound of dehumidifier. • This is sound generated when heat exchanger, etc. expand and contract slightly due to change of temperature. • Various smell such as one of wall, carpet, clothes, cigarette, or cosmetics adhere to the air conditioner. • When cooling operation cannot be performed because another indoor unit performs heating operation. • When the manager of the air conditioner has fixed the operation to COOL or HEAT, and an operation contrary to the setup operation is performed. • When fan operation stopped to prevent discharge of hot air. • Since refrigerant is flowed temporarily to prevent stay of oil or refrigerant in the stand by indoor unit, sound of flowing refrigerant, "Kyururu" or "Shaa" may be heard or white steam when other indoor unit operates in HEAT mode, and cold air in COOL mode may be blow-out. • Sound is generated when the expansion valve operates when power has been turned on. • Intermittent operation of the fan with louvers open is sometimes carried out for the refrigerant recovery control of unoperated unit.
Check again.	Operates or stops automatically.	<ul style="list-style-type: none"> • Is the timer "ON" or "OFF"?
	Does not operate.	<ul style="list-style-type: none"> • Is it a power failure? • Is the power switch turned off? • Is the power fuse or breaker blown? • Has the protective device operated? (The operation lamp goes on.) • Is the timer "ON"? (The operation lamp goes on.) • Are COOL and HEAT selected simultaneously? ("⊕" indication is lit on the display of the remote controller.)
	Air is not cooled or warmed sufficiently. 	<ul style="list-style-type: none"> • Is the air inlet or air outlet of the outdoor unit obstructed? • Are any door or window open? • Is the air filter clogged with dust? • Is discharge louver of the indoor unit set at appropriate position? • Is air selection set to "LOW" "MED", and is the operation mode set to "FAN"? • Is the setup temp. the appropriate temperature? • Are COOL and HEAT selected simultaneously? ("⊕" indication is lit on the display of the remote controller.)

CAUTION

If any of the following conditions occur, turn off the main power supply switch and immediately contact the dealer :

- Switch operation does not work properly.
- The main power fuse often blows out, or the circuit breaker is often activated.
- A foreign matter or water fall inside the air conditioner.
- When the air conditioner does not operate even after the cause of the protective device activation has been removed. (The operation lamp and  on the remote controller are flashing.)
- Any other unusual conditions are observed.

Confirmation and check

When a trouble occurred in the air conditioner, the check code and the indoor unit No. appear on the display part of the remote controller.

The check code is only displayed during the operation.

If the display disappears, operate the air conditioner according to the following "Confirmation of error history" for confirmation.

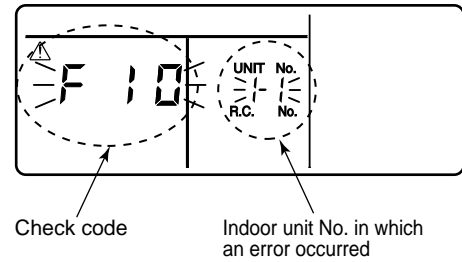



Confirmation of error history

When a trouble occurred on the air conditioner, the trouble history can be confirmed with the following procedure. (The trouble history is stored in memory up to 4 troubles.)

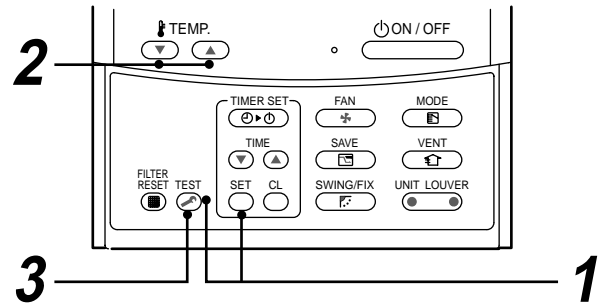
The history can be confirmed from both operating status and stop status.

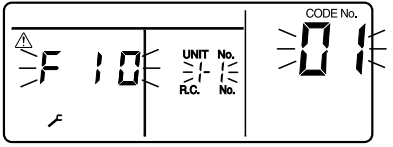

Procedure	Description
1	<p>When pushing ^{SET} and ^{TEST} buttons at the same time for 4 seconds or more, the following display appears.</p> <p>If [ Service check] is displayed, the mode enters in the trouble history mode.</p> <ul style="list-style-type: none"> • [01 : Order of trouble history] is displayed in CODE No. window. • [Check code] is displayed. • [Indoor unit address in which an error occurred] is displayed in UNIT No. 
2	<p>Every pushing of [ / ] button used to set temperature, the trouble history stored in memory is displayed in order.</p> <p>The numbers in CODE No. indicate CODE No. [01] (latest) → [04] (oldest).</p> <p>CAUTION</p> <p>Do not push ^{CL} button because all the trouble history of the indoor unit will be deleted.</p>
3	<p>After confirmation, push ^{TEST} button to return to the usual display.</p>

1. Check the troubles according to the above procedure.
2. Ask an authorized dealer or qualified service (maintenance) professional to repair or maintain the air conditioner.
3. More details of the service code are explained in Service Manual.

Check these items.

If any of these problems still remains, stop the operation, turn off the leakage breaker, and then notifies the dealer of the serial number and details of the error. Never repair any part by yourself as it is dangerous.

When  and a combination of *E*, *F*, *H*, *L*, or *P* and a number are displayed on the remote controller, also inform the dealer of the display content.

6. REFRIGERATING CYCLE DIAGRAM

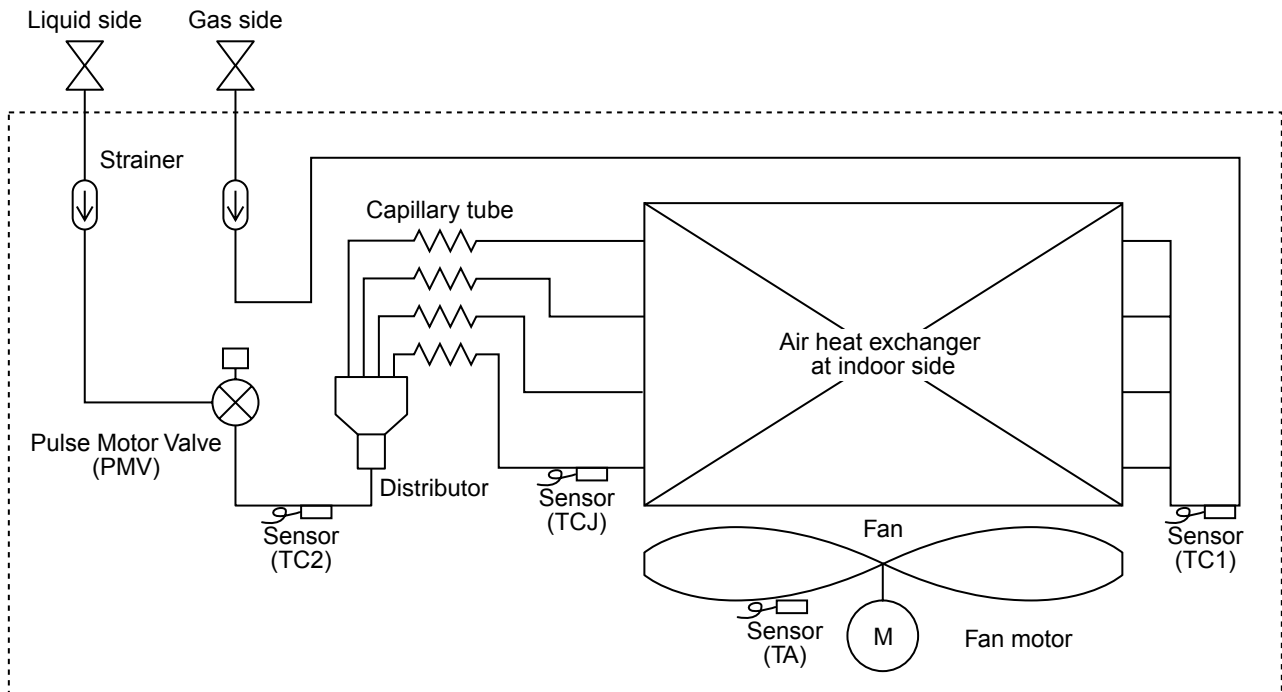

Functional part name		Functional outline
Pulse Motor Valve	PMV	(Connector CN082 (6P): Blue) 1) Controls super heat in cooling operation 2) Controls under cool in heating operation 3) Recovers refrigerant oil in cooling operation 4) Recovers refrigerant oil in heating operation
Temp. sensor	1. TA	(Connector CN104 (2P): White) 1) Detects indoor suction temperature
	2. TC1	(Connector CN100 (3P): Brown) 1) Controls PMV super heat in cooling operation
	3. TC2	(Connector CN101 (2P): Blue) 1) Controls PMV under cool in heating operation
	4. TCJ	(Connector CN102 (2P): Yellow) 1) Controls PMV super heat in cooling operation







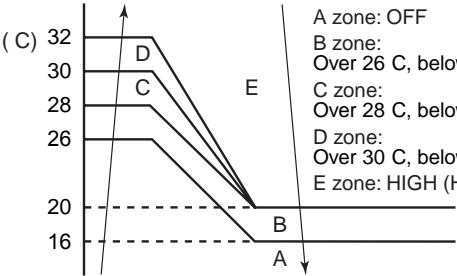
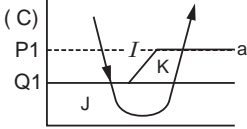
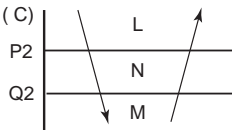

7. CONTROL OUTLINE





7-1. Control Specifications



No.	Item	Outline of specifications	Remarks																										
1	When power supply is reset	1) Distinction of outdoor unit When the power supply is reset, the outdoors are distinguished and the control is selected according to the distinguished result. 2) If resetting the power supply during occurrence of a trouble, the check code is once cleared. After ON/OFF button of the remote controller was pushed and the operation was resumed, if the abnormal status continues, the check code is again displayed on the remote controller.																											
2	Operation mode selection	1) Based on the operation mode selecting command from the remote controller, the operation mode is selected. <table border="1" style="margin: 10px auto; width: 80%;"> <thead> <tr> <th style="text-align: center;">Remote controller command</th> <th style="text-align: center;">Control outline</th> </tr> </thead> <tbody> <tr> <td style="text-align: center;">STOP</td> <td>Air conditioner stops.</td> </tr> <tr> <td style="text-align: center;">FAN</td> <td>Fan operation</td> </tr> <tr> <td style="text-align: center;">COOL</td> <td>Cooling operation</td> </tr> <tr> <td style="text-align: center;">DRY</td> <td>Dry operation</td> </tr> <tr> <td style="text-align: center;">HEAT</td> <td>Heating operation</td> </tr> <tr> <td style="text-align: center;">AUTO (SHRM only)</td> <td> <ul style="list-style-type: none"> • Ta and Ts automatically select COOL/HEAT operation mode for operation. </td> </tr> </tbody> </table> <p style="margin-top: 10px;">* Except SHRM, the automatic mode cannot be selected. While a wireless remote controller is used, the mode is notified by "Pi Pi" (two times) receiving sound. To clear the alternate flashing, change the mode on the wireless remote controller.</p>	Remote controller command	Control outline	STOP	Air conditioner stops.	FAN	Fan operation	COOL	Cooling operation	DRY	Dry operation	HEAT	Heating operation	AUTO (SHRM only)	<ul style="list-style-type: none"> • Ta and Ts automatically select COOL/HEAT operation mode for operation. 	Ta: Room temp. Ts: Setup temp.												
Remote controller command	Control outline																												
STOP	Air conditioner stops.																												
FAN	Fan operation																												
COOL	Cooling operation																												
DRY	Dry operation																												
HEAT	Heating operation																												
AUTO (SHRM only)	<ul style="list-style-type: none"> • Ta and Ts automatically select COOL/HEAT operation mode for operation. 																												
3	Room temp. control	1) Adjustment range: Remote controller setup temperature (°C) <table border="1" style="margin: 10px auto; width: 80%;"> <thead> <tr> <th></th> <th style="text-align: center;">COOL/DRY</th> <th style="text-align: center;">HEAT</th> <th style="text-align: center;">AUTO*</th> </tr> </thead> <tbody> <tr> <td style="text-align: center;">Wired type</td> <td style="text-align: center;">18 to 29</td> <td style="text-align: center;">18 to 29</td> <td style="text-align: center;">18 to 29</td> </tr> <tr> <td style="text-align: center;">Wireless type</td> <td style="text-align: center;">17 to 30</td> <td style="text-align: center;">17 to 30</td> <td style="text-align: center;">17 to 30</td> </tr> </tbody> </table> 2) Using the Item code 06, the setup temperature in heating operation can be corrected. <table border="1" style="margin: 10px auto; width: 80%;"> <thead> <tr> <th style="text-align: center;">Setup data</th> <th style="text-align: center;">0</th> <th style="text-align: center;">2</th> <th style="text-align: center;">3</th> <th style="text-align: center;">4</th> <th style="text-align: center;">6</th> </tr> </thead> <tbody> <tr> <td style="text-align: center;">Setup temp. correction</td> <td style="text-align: center;">+0°C</td> <td style="text-align: center;">+2°C</td> <td style="text-align: center;">+3°C</td> <td style="text-align: center;">+4°C</td> <td style="text-align: center;">+6°C</td> </tr> </tbody> </table> <p style="margin-top: 10px;">Setting at shipment</p> <table border="1" style="margin: 10px auto; width: 80%;"> <tbody> <tr> <td style="text-align: center;">Setup data</td> <td style="text-align: center;">3</td> </tr> </tbody> </table>		COOL/DRY	HEAT	AUTO*	Wired type	18 to 29	18 to 29	18 to 29	Wireless type	17 to 30	17 to 30	17 to 30	Setup data	0	2	3	4	6	Setup temp. correction	+0°C	+2°C	+3°C	+4°C	+6°C	Setup data	3	* For SHRM only Shift of suction temperature in heating operation Except while sensor of the remote controller is controlled (Code No. [32], "0001")
	COOL/DRY	HEAT	AUTO*																										
Wired type	18 to 29	18 to 29	18 to 29																										
Wireless type	17 to 30	17 to 30	17 to 30																										
Setup data	0	2	3	4	6																								
Setup temp. correction	+0°C	+2°C	+3°C	+4°C	+6°C																								
Setup data	3																												
4	Automatic capacity control	1) Based on the difference between Ta and Ts, the operation capacity is determined by the outdoor unit.	Ts: Setup temp. Ta: Room temp.																										

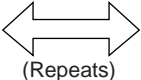

No.	Item	Outline of specifications	Remarks															
5	Air speed selection	1) Operation with (HH), (H), (L) or [AUTO] mode is carried out by the command from the remote controller. For the wireless remote controller type, (HH), (H+), (H), (L+), (L) or [AUTO] operation is carried out. 2) When the air speed mode [AUTO] is selected, the air speed varies by the difference between Ta and Ts.	HH > H+ > H > L+ > L > UL															
6	Prevention of cold air discharge	1. In heating operation, the higher temperature of TC2 sensor and TCJ sensor is compared with temperature of TC1 sensor and then the lower temperature is used to set the upper limit of the fan tap. <ul style="list-style-type: none"> When B zone has continued for 6 minutes, the operation shifts to C zone. In defrost time, the control point is set to +6°C.  <p style="font-size: small;"> A zone: OFF B zone: Over 26 C, below 28 C, ULTRA LOW (LL) C zone: Over 28 C, below 30 C, LOW (L) D zone: Over 30 C, below 32 C, MED (H) E zone: HIGH (HH) </p>	TCJ: Temperature of indoor heat exchanger sensor <ul style="list-style-type: none"> In D and E zones, priority is given to remote controller air speed setup. In A zone “☀” is displayed. 															
7	Freeze prevention control (Low temp. release)	1. In all cooling operation, the air conditioner operates as described below based upon temp. detected by TC1, TC2 and TCJ sensors. <ul style="list-style-type: none"> When “J” zone is detected for 5 minutes, the thermostat is forcedly off. In “K” zone, the timer count is interrupted, and held. When “I” zone is detected, the timer is cleared and the operation returns to the normal operation. If forced thermo OFF by continuation of “J” zone, operation of the indoor fan in LOW mode continues until it reaches the “I” zone. It is rest when the following conditions are satisfied. Reset conditions <ol style="list-style-type: none"> TC1 ≥ 12°C and TC2 ≥ 12°C and TCJ ≥ 12°C 20 minutes passed after stop.  <table border="1" data-bbox="758 1444 1077 1556"> <thead> <tr> <th></th> <th>TC1</th> <th>TC2, TCJ</th> </tr> </thead> <tbody> <tr> <td>P1</td> <td>10°C (5°C)</td> <td>-10°C</td> </tr> <tr> <td>Q1</td> <td>0°C</td> <td>-14°C</td> </tr> </tbody> </table> 2. In all cooling operation, the air conditioner operates as described below based upon temp. detected by TC2 and TCJ sensors. <ul style="list-style-type: none"> When “M” zone is detected for 45 minutes, the thermostat is forcedly off. In “N” zone, the timer count is interrupted and held. When shifting to “M” zone again, the timer count restarts and continues. If “L” zone is detected, the timer is cleared and the operation returns to normal operation. Reset conditions <ol style="list-style-type: none"> TC1 ≥ 12°C and TC2 ≥ 12°C and TCJ ≥ 12°C 20 minutes passed after stop.  <table border="1" data-bbox="810 1944 1077 2056"> <thead> <tr> <th></th> <th>TC2, TCJ</th> </tr> </thead> <tbody> <tr> <td>P2</td> <td>5°C</td> </tr> <tr> <td>Q2</td> <td>-2.0°C</td> </tr> </tbody> </table>		TC1	TC2, TCJ	P1	10°C (5°C)	-10°C	Q1	0°C	-14°C		TC2, TCJ	P2	5°C	Q2	-2.0°C	TC1: Temperature of indoor heat exchanger sensor () value: When the power supply is turned on, the Forced thermo becomes OFF if the temperature is less than this indicated temperature.
	TC1	TC2, TCJ																
P1	10°C (5°C)	-10°C																
Q1	0°C	-14°C																
	TC2, TCJ																	
P2	5°C																	
Q2	-2.0°C																	

No.	Item	Outline of specifications	Remarks
8	Recovery control for cooling oil (Refrigerant)	<p>The indoor unit which is under STOP/Thermo-OFF status or which operates in [FAN] mode performs the following controls when it received the cooling oil (Refrigerant) recovery signal from the outdoor unit.</p> <ol style="list-style-type: none"> 1) Opens PMV of the indoor unit with a constant opening degree. 2) Stop the indoor fan. 	<ul style="list-style-type: none"> • Recovery operation is usually performed every 2 hours.
9	Recovery control for heating refrigerant (Oil)	<p>The indoor unit which is under STOP/Thermo-OFF status or which operates in [FAN] mode performs the following controls when it received the heating refrigerant (Oil) recovery signal from the outdoor unit.</p> <ol style="list-style-type: none"> 1) Opens PMV of the indoor unit with a constant opening degree. 2) Stop the indoor fan. 	<ul style="list-style-type: none"> • The indoor unit which is under thermo-OFF (COOL) status or which operates in [FAN] mode stops the indoor fan and displays [❄]. • Recovery operation is usually performed every 1 hour.
10	Compensation control for short intermittent operation	<ol style="list-style-type: none"> 1) For 3 minutes after start of operation, the operation is forcibly continued even if the unit enters in Thermo-OFF condition. 2) However the thermostat is OFF giving prior to COOL/HEAT selection, ready for operation and protective control. 	Usually the priority is given to 5 minutes at outdoor controller side.
11	Elimination of retained heat	<ol style="list-style-type: none"> 1) When the unit stopped from [HEAT] operation, the indoor fan operates with [L] for approx. 30 seconds. 	
12	HA control	<ol style="list-style-type: none"> 1) ON/OFF operation is available by input of HA signal from the remote site when connected to remote controller or the remote ON/OFF interface. 2) HA control outputs ON/OFF status to HA terminal. 3) The I/O specifications of HA conform to JEMA standard. 	<p>When using HA terminal (CN61) for the remote ON/OFF, a connector sold separately is necessary.</p> <p>In case of group operation, use the connector to connect HA terminal to either master or follower indoor unit.</p>
13	<p>Display of filter sign [🌀] (Not provided to the wireless type)</p> <p>* Separately set type TCB-AX21E2 is prepared.</p>	<ol style="list-style-type: none"> 1) The filter sign is displayed with LC by sending the filter-reset signal to the remote controller when the specified time (15 0H) elapsed as a result of integration of the operation time of the indoor fan. 2) The integrated timer is cleared when the filter-reset signal is received from the remote controller. In this time, if the specified time elapsed, the counted time is reset and the LC display is deleted. 	[🌀 FILTER] goes on.

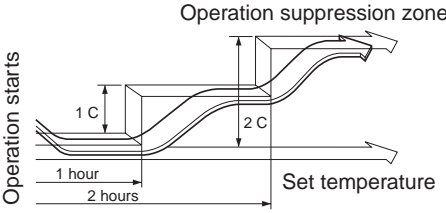
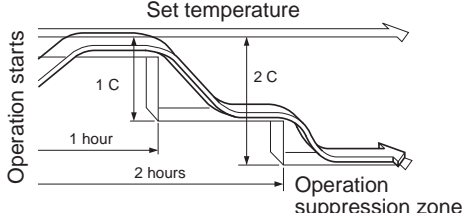
No.	Item	Outline of specifications	Remarks																																																			
14	Display of [ OPERATION READY] [ PRE-HEAT]	<p><OPERATION READY> Displayed on the remote controller</p> <ol style="list-style-type: none"> When the following check codes are indicated <ul style="list-style-type: none"> Open phase of power supply wiring [P05] was detected. There is an indoor unit that detected the indoor overflow [P10]. There is an indoor unit that detected the interlock alarm [L30]. During Force Thermo-OFF <ul style="list-style-type: none"> [COOL/DRY] operation is unavailable because the other indoor unit operates with [HEAT] mode. [HEAT] operation is unavailable because COOL priority (SW11-bit1 of the Outdoor I/F P. C. board is ON) is set and the other indoor unit operates with [COOL/DRY] mode. The above indoor units that cannot operate stay in Thermo-OFF status. The indoor fan stops because the system performs [Recovery operation for heating refrigerant (Oil)]. <p><PRE-HEAT> Displayed on the remote controller The indoor fan stops in order to prevent discharge of cool air when heating operation started or during heating operation. (including the defrost operation during thermo-OFF)</p>	<ul style="list-style-type: none"> <  > display No display for wireless remote controller <  > display 																																																			
15	Selection of central control mode	<ol style="list-style-type: none"> Selection of the contents that can be operated by the remote controller at the indoor unit side is possible according to setting at the central controller side. Setting contents <p>• In case of TCC-LINK central control</p> <table border="1" data-bbox="239 1176 1420 1429"> <thead> <tr> <th rowspan="2">Operation from TCC-LINK central control</th> <th colspan="6">Operation on RBC-AMT32E</th> <th rowspan="2">On RBC-AMT32E</th> </tr> <tr> <th>ON/OFF setting</th> <th>Operation selection</th> <th>Timer setting</th> <th>Temp. setting</th> <th>Air speed setting</th> <th>Air direction setting</th> </tr> </thead> <tbody> <tr> <td>Individual</td> <td>○</td> <td>○</td> <td>○</td> <td>○</td> <td>○</td> <td>○</td> <td>No display</td> </tr> <tr> <td>[Central 1]</td> <td>✕</td> <td>○</td> <td>✕</td> <td>○</td> <td>○</td> <td>○</td> <td rowspan="4">[Central control ] display</td> </tr> <tr> <td>[Central 2]</td> <td>✕</td> <td>✕</td> <td>✕</td> <td>✕</td> <td>○</td> <td>○</td> </tr> <tr> <td>[Central 3]</td> <td>○</td> <td>✕</td> <td>○</td> <td>✕</td> <td>○</td> <td>○</td> </tr> <tr> <td>[Central 4]</td> <td>○</td> <td>✕</td> <td>○</td> <td>○</td> <td>○</td> <td>○</td> </tr> </tbody> </table> <p>(○: Operation possible ✕: Operation impossible)</p> <ul style="list-style-type: none"> In case of wired remote controller type, [Central control ] display (Goes on) in the central control mode Display flashes when an item of the operation prohibited was changed on the remote controller. In case of wireless remote controller type, the display lamp does not change but the contents that can be operated are same in the central control mode. <p>(*1) The operation from the wireless remote controller in the central control mode is notified with the receiving sound, Pi, Pi, Pi, Pi, Pi (5 times).</p> <p>(*1) If the operation select modes are different in the central 2 to 4 from those at the central controller side, the operations Temp. Setting, air volume setting, and air direction setting are inoperable.</p>	Operation from TCC-LINK central control	Operation on RBC-AMT32E						On RBC-AMT32E	ON/OFF setting	Operation selection	Timer setting	Temp. setting	Air speed setting	Air direction setting	Individual	○	○	○	○	○	○	No display	[Central 1]	✕	○	✕	○	○	○	[Central control ] display	[Central 2]	✕	✕	✕	✕	○	○	[Central 3]	○	✕	○	✕	○	○	[Central 4]	○	✕	○	○	○	○	
Operation from TCC-LINK central control	Operation on RBC-AMT32E						On RBC-AMT32E																																															
	ON/OFF setting	Operation selection	Timer setting	Temp. setting	Air speed setting	Air direction setting																																																
Individual	○	○	○	○	○	○	No display																																															
[Central 1]	✕	○	✕	○	○	○	[Central control ] display																																															
[Central 2]	✕	✕	✕	✕	○	○																																																
[Central 3]	○	✕	○	✕	○	○																																																
[Central 4]	○	✕	○	○	○	○																																																

No.	Item	Outline of specifications	Remarks
16	Louver control	<p>1) Louver position setup (Wired type)</p> <ul style="list-style-type: none"> The louver position can be set up in the following operation range. <p style="text-align: center;">In cooling/dry operation In heating/fan operation</p> <div style="display: flex; justify-content: space-around; align-items: center;">   </div> <ul style="list-style-type: none"> In group operation, the louver positions can be set up collectively or individually. <p>2) Swing setup</p> <ul style="list-style-type: none"> The following display is repeated. <p style="text-align: center;">In all operations</p> <div style="display: flex; justify-content: center; align-items: center;">    </div> <ul style="list-style-type: none"> In group operation, the louver positions can be set up collectively or individually. <p>3) FIX setup (Wireless type)</p> <p>Keep pushing or pushing briefly the FIX button to move the louver in the desired direction.</p> <p>Operating angle of louver will be different during cooling, dry and heating operation.</p> <p>4) When the unit stopped or the warning was output, the louver is automatically set to full closed position.</p> <p>5) When PRE-HEAT (⊗) is displayed (Heating operation started or defrost operation is performed), heating thermo is off, the louver is automatically set to closed.</p>	
17	Hi POWER operation (Wireless remote controller specific operations)	<p>When you push the Hi POWER button during cooling, heating or A operation, the air conditioner will start the following operation.</p> <ul style="list-style-type: none"> Cooling operation Performs the cooling operation at 1°C lower than the setting temperature. Only when the fan speed before the Hi POWER operation is not high, the fan speed will be increased. When the Hi POWER is selected, running time for the damper control is cleared once. Heating operation Performs the heating operation at 2°C higher than the setting temperature. Only when the fan speed before the Hi POWER operation is not high, the fan speed will be increased. 	<ul style="list-style-type: none"> [Hi POWER] Display

No.	Item	Outline of specifications	Remarks
18	COMFORT SLEEP operation (Wireless remote controller specific operations)	<p>When you push the COMFORT SLEEP button during cooling, heating or A operation, the air conditioner will start the following operation.</p> <p>The fan speed display will indicate AUTO and low speed will be used.</p> <ul style="list-style-type: none"> Cooling operation In the operation suppression zone, where capacity is kept to the minimum, overcooling is prevented by raising the temperature setting by 1°C after 1 hour and by 2°C after 2 hours of operation. The room temperature is thus regulated between the operation suppression zone and the set temperature. Heating operation In the operation suppression zone, where capacity is kept to the minimum, overheating is prevented by lowering the temperature setting by 1°C after 1 hour and by 2°C after 2 hours of operation. The room temperature is thus regulated between the set temperature and the operation suppression zone. <p>When the OFF timer is simultaneously set, 1, 3, 5 and 9 hours appear by turns every pushing COMFORT SLEEP button and one of them can be selected for OFF timer.</p> <div style="display: flex; justify-content: space-around; align-items: flex-end;">   </div>	<ul style="list-style-type: none"> [] display
19	PRESET operation (Wireless remote controller specific operations)	<p>Start the air conditioner in the operation mode which you want the remote controller to memorize.</p> <ol style="list-style-type: none"> Push and hold the PRESET button for more than 3 seconds while the display flashes. <ul style="list-style-type: none"> The mark is indicated and the setting is memorized. If you do not push the PRESET button within 3 seconds or if you push another button, the memory setting is cancelled. Operation modes which can be memorized with the PRESET button are MODE, Temperatures, FAN, TIMER and Hi POWER. <p>To operate the air conditioner with the setting memorized by the PRESET button.</p> <ol style="list-style-type: none"> Push the PRESET button briefly. <ul style="list-style-type: none"> The setting memorized will be indicated and the air conditioner operates with regards to the setting. The lamp (green) on the display panel of the indoor unit goes on, and operation starts after approximately 3 minutes. Initial setting: MODE : AUTO Temperature : 22 	<ul style="list-style-type: none"> [] display

No.	Item	Outline of specifications	Remarks
20	QUIET operation (Wireless remote controller specific operation)	<p>When you push the QUIET button during cooling, heating, fan only or A operation, the air conditioner will start the following operation.</p> <ul style="list-style-type: none"> The fan speed display will indicate AUTO and low speed will be used. 	<ul style="list-style-type: none"> [] display
21	SLEEP operation (Wireless remote controller specific operation)	<p>When the OFF timer is set, 1, 3, 5 and 9 hours appear by turns every pushing SLEEP button and one of them can be selected for OFF timer.</p>	
22	Save operation	<p>1) The function [Save operation] is not provided to the Super Modular Multi series models.</p>	<ul style="list-style-type: none"> If pushing [SAVE] button “  ” on the remote controller, “No function” is displayed.

8. CONFIGURATION OF CONTROL CIRCUIT

8-1. Indoor Controller Block Diagram

8-1-1. Case of Main (Sub) Remote Controller Connected

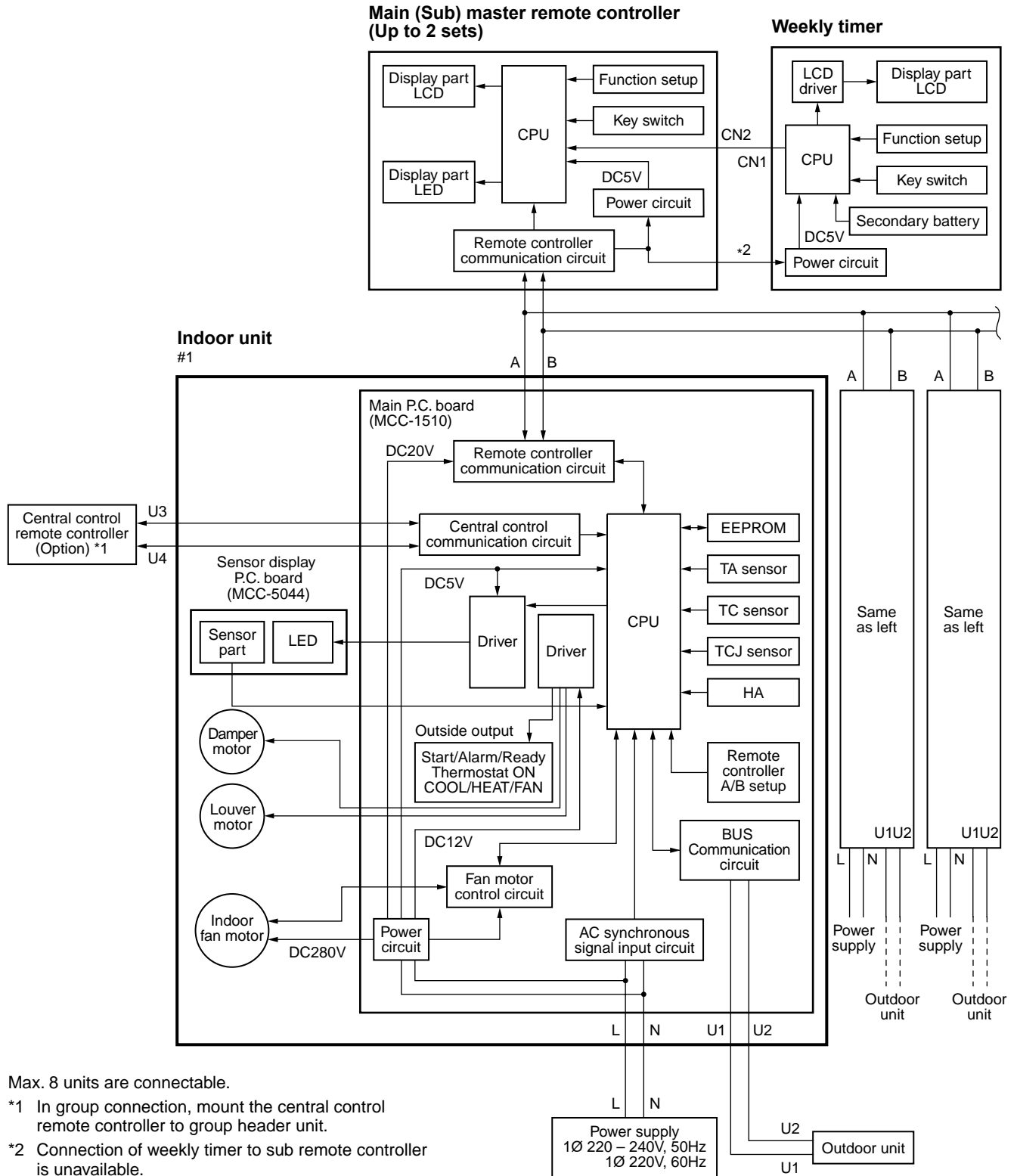

Max. 8 units are connectable.

*1 In group connection, mount the central control remote controller to group header unit.

*2 Connection of weekly timer to sub remote controller is unavailable.

8-1-2. Case of Wireless Remote Controller Kit Connected

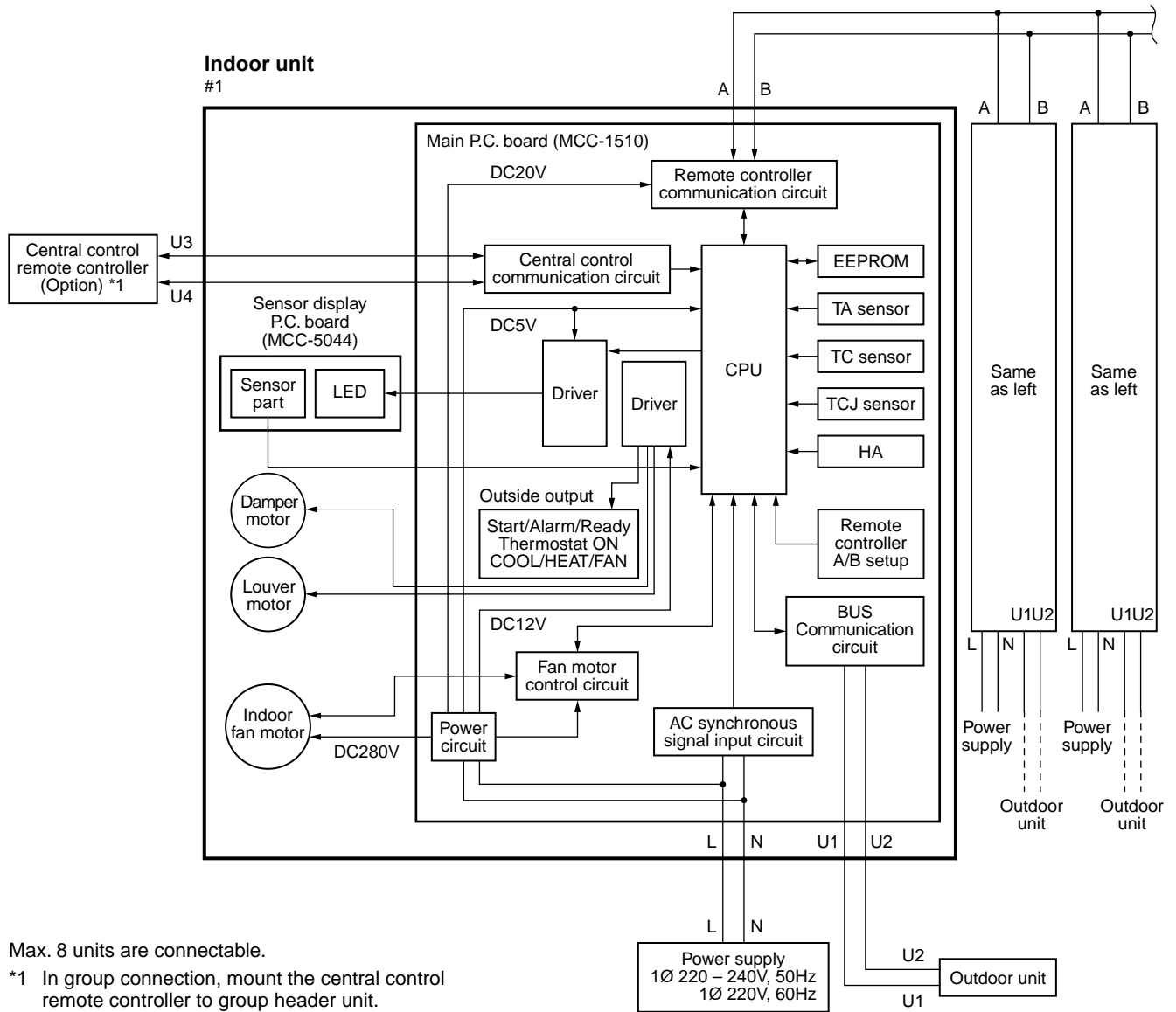

Max. 8 units are connectable.

*1 In group connection, mount the central control remote controller to group header unit.

■ 8-2. Indoor P.C. Board

MCC-1510

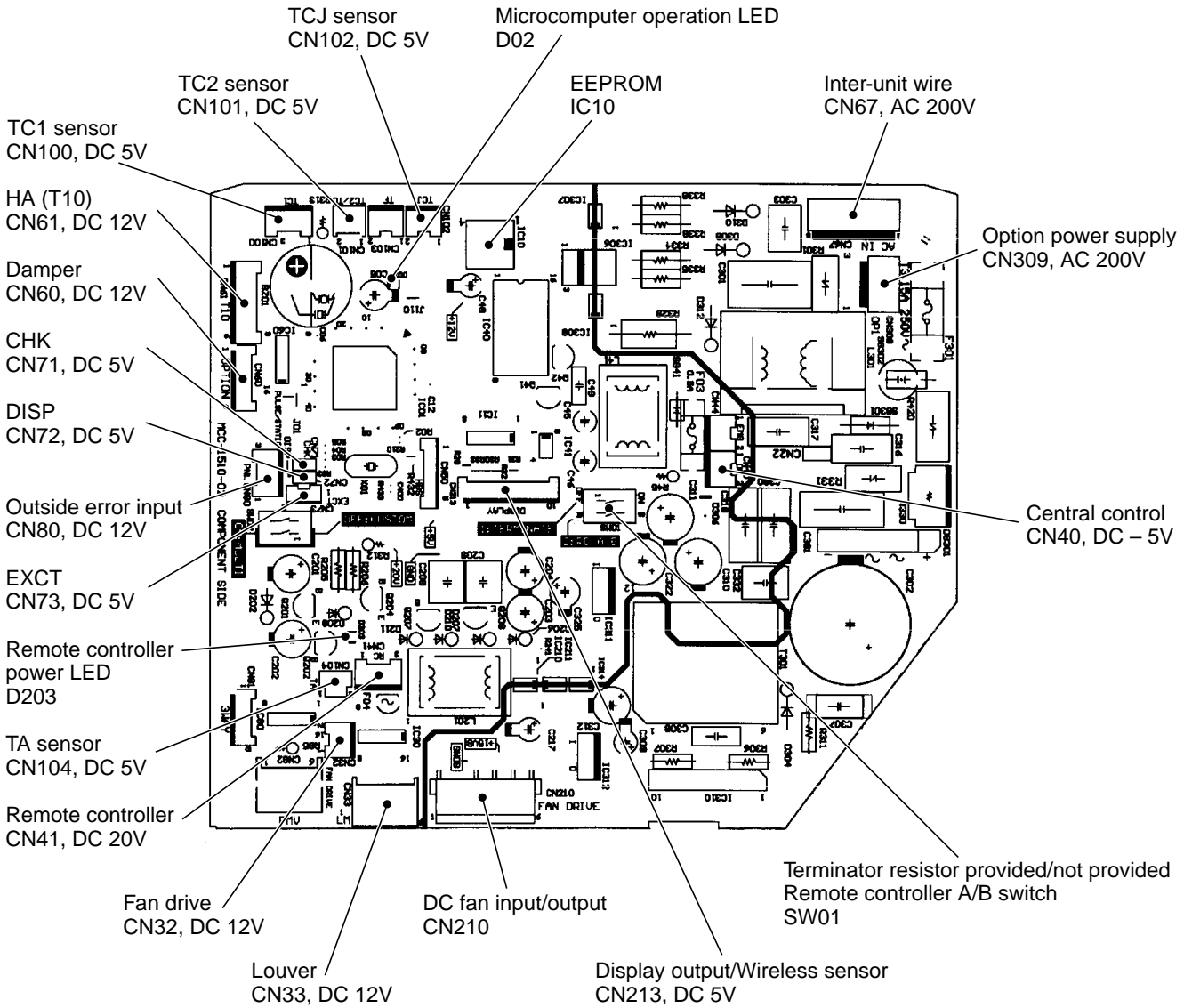

8-2-1.Console-Type P.C. Board Optional Switch/Connector Specifications

Function	Connector No.	Pin No.	Specifications	Remarks
Terminator resistor provided/Not provided	SW01	Bit 1	OFF: No terminator resistor, ON: Terminator resistor provided	Setup at shipment OFF: No terminator resistor. Only 1 unit is ON during central control by custom only.
Remote controller A/B		Bit 2	OFF: Remote controller A ON: Remote controller B	Setup at shipment OFF: Remote controller A
Fan output	CN32	1	DC12V	Setup at shipment: Linked operation of ON with operation of indoor unit and OFF with stop
		2	Output	* The setup of single operation by FAN button on remote controller is executed from remote controller. (DN = 31)
HA	CN61	1	Start/Stop input	HA Start/Stop input (J01: Provided/Not provided = Pulse (At shipment from factory)/Static input switch)
		2	0V (COM)	
		3	Handy prohibition input	Operation stop of handy remote controller is permitted / prohibited by input.
		4	Operation output	ON during operation (Answer back of HA)
		5	DC12V (COM)	
		6	Alarm output	ON during output of alarm
Outside error input	CN80	1	DC12V (COM)	At shipment from factory, the error code "L30" generates and optional error input to stop operation forcedly (DN:2A = 1) is controlled (Display of protection for devices attached to outside) by setup of outside error input (DN:2A = 2) for 1 minute.
		2	DC12V (COM)	
		3	Filter/Option/Outside error input	* Optional error input control is set up on the remote controller.
CHK Operation check	CN71	1	Check mode input	This check is used for operation check of indoor unit. (The specified operation such as indoor fan "H", drain pump ON, etc. is executed without communication with outdoor unit or remote controller.)
		2	0V	
DISP Display mode	CN72	1	Display mode input	Display mode, communication is enabled by indoor unit and remote controller only. (When power supply is turned on.)
		2	0V	Timer short (Usual)
EXCT Demand	CN73	1	Demand input	Indoor unit forced thermo-OFF operation
		2	0V	

8-3. Functions at test run

■ Cooling/Heating test run check

The test run for cooling/heating can be performed from either indoor remote controller or outdoor interface P.C. board.

1. Start/Finish operation of test run

◎ Test run from indoor remote controller

- Wired remote controller: Refer to the below item of “Test run” of the wired remote controller.
- Wireless remote controller: Refer to the next page item of “Test run” of the wireless remote controller.

◆ In case of wired remote controller

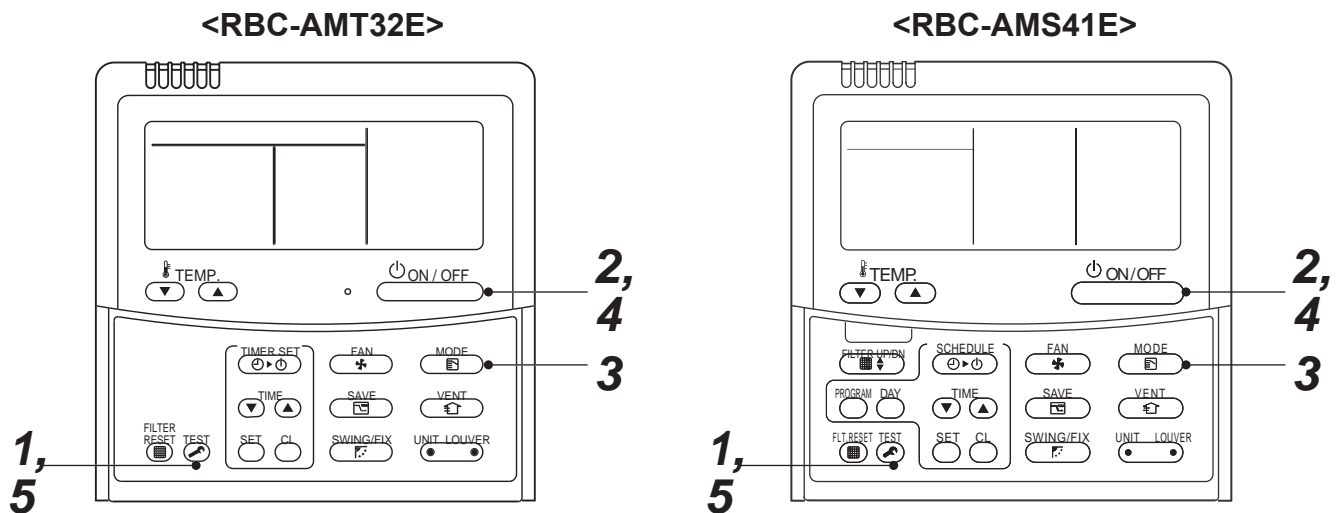

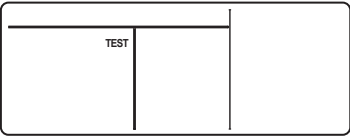
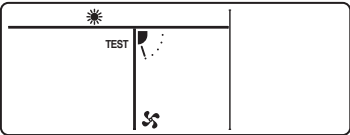
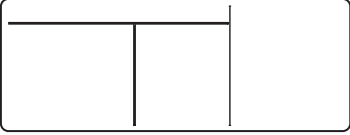
Procedure	Operation contents
1	<p>Push [TEST] button for 4 seconds or more. [TEST] is displayed at the display part and the mode enters in TEST mode.</p> 
2	<p>Push [ON/OFF] button.</p>
3	<p>Change the mode from [COOL] to [HEAT] using [MODE] button.</p> <ul style="list-style-type: none"> • Do not use [MODE] button for other mode except [COOL]/[HEAT] modes. • The temperature cannot be adjusted during test run. • The error detection is performed as usual. 
4	<p>After test run, push [ON/OFF] button to stop the operation. (Display on the display part is same to that in Procedure 1.)</p>
5	<p>Push [TEST] button to clear the TEST mode. ([TEST] display in the display part disappears and status becomes the normal stop status.)</p> 

Note) The test run returns to the normal operation after 60 minutes.



◆ In case of wireless remote controller

In case of wireless remote controller (Forced test operation is performed in a different way.)

REQUIREMENT

- For the operation procedure, be sure to follow the Owner's Manual.
- Finish the forced cooling operation in a short time because it applies excessive strength to the air conditioner.
- A test operation of forced heating is unavailable. Perform a test operation by heating operation using the switches of the remote controller.
However heating operation may be not carried out according to the temperature conditions.

• Check wiring/piping of indoor and outdoor units

1. When pushing  button for 10 seconds or more, "Pi!" sound is heard and the operation changes to a forced cooling operation. After approx. 3 minutes, a cooling operation starts forcedly.
Check cool air starts blowing. If the operation does not start, check wiring again.
2. To stop a test operation, push  button once again (Approx. 1 second).
The louver closes and the operation stops.

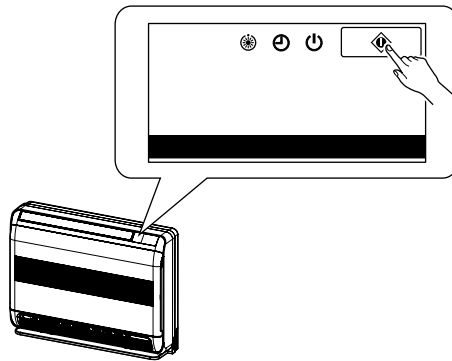

• Check transmission of remote controller

1. Push "START/STOP" button of the remote controller to check an operation can also start by the remote controller.
 - "Cooling" operation by the remote controller may be unavailable according to the temperature conditions.
Check wiring/piping of the indoor and outdoor units in forced cooling operation.

9. APPLIED CONTROL

9-1. Indoor Unit

9-1-1. Setup of Selecting Function in Indoor Unit (Be Sure to Execute Setup by a Wired Remote Controller)

<Procedure> Execute the setup operation while the unit stops.

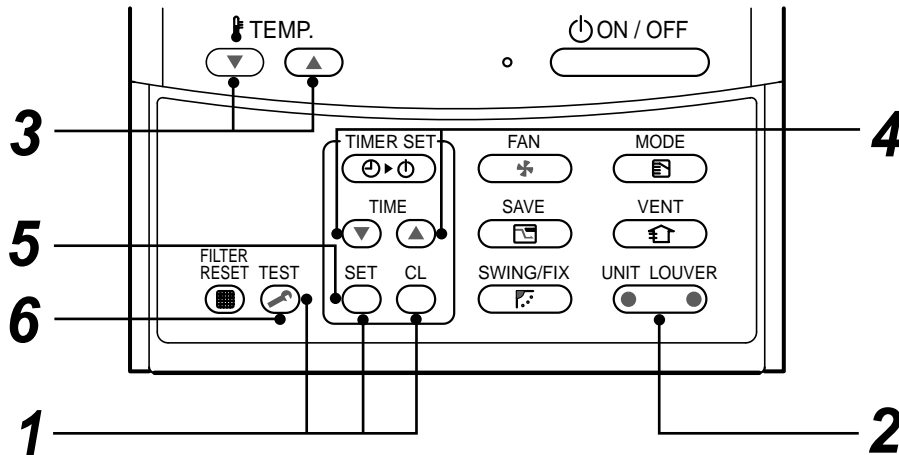

- 1** Push **SET**, **CL**, and **TEST** buttons simultaneously for 4 seconds or more.
The firstly displayed unit No. indicates the header indoor unit address in the group control.
In this time, the fan of the selected indoor unit is turned on.
- 2** Every pushing **UNIT LOUVER** button, the indoor unit numbers in the group control are successively displayed. In this time, the fan of the selected indoor unit only is turned on.
- 3** Specify the item code (DN) using the setup temperature **▼** and **▲** buttons.
- 4** Select the setup data using the timer time **▼** and **▲** buttons.
(When selecting the DN code to “33”, change the temperature indication of the unit from “°C” to “°F” on the remote controller.)
- 5** Push **SET** button. (OK if display goes on.)
 - To change the selected indoor unit, return to **procedure 2**.
 - To change the item to be set up, return to **procedure 3**.
- 6** Pushing **TEST** button returns the status to normal stop status.

Table: Function selecting item numbers (DN)
(Items necessary to perform the applied control at the local site are described.)

DN	Item	Description	At shipment
01	Filter display delay timer	0000 : None 0002 : 2500H 0004 : 10000H 0001 : 150H 0003 : 5000H	0001 : 150H
02	Dirty state of filter	0000 : Standard 0001 : High degree of dirt (Half of standard time)	0000 : Standard
03	Central control address	0001 : No.1 unit to 0064 : No.64 unit 0099 : Unfixed	0099 : Unfixed
04	Specific indoor unit priority	0000 : No priority 0001 : Priority	0000 : No priority
06	Heating temp shift	0000 : No shift 0002 : +2°C to 0003 : +3°C 0010 : +10°C (Up to +6 recommended)	0000 : No shift
0d	Existence of [AUTO] cool / heat mode	0000 : Provided 0001 : Not provided (Automatic selection from connected outdoor unit)	0001 : Not provided
0F	Cooling only	0000 : Heat pump 0001 : Cooling only (No display of [AUTO] [HEAT])	0000 : Heat pump
10	Type	0018: Console	Depending on model type
11	Indoor unit capacity	0000 : Unfixed 0001 to 0034	According to capacity type
12	Line address	0001 : No.1 unit to 0030 : No.30 unit	0099 : Unfixed
13	Indoor unit address	0001 : No.1 unit to 0064 : No.64 unit	0099 : Unfixed
14	Group address	0000 : Individual 0002 : Follower unit of group 0001 : Header unit of group	0099 : Unfixed
1E	Temp difference of [AUTO] mode selection COOL → HEAT, HEAT → COOL	0000 : 0 deg to 0010 : 10 deg (For setup temperature, reversal of COOL/HEAT by ± (Data value)/2)	0003 : 3 deg (Ts±1.5)
28	Automatic restart of power failure	0000 : None 0001 : Restart	0000 : None
2A	Selection of option/error input (CN80)	0000 : Filter input 0002 : Outside error input 0001 : Alarm input (Air washer, etc.)	0002 : Outside error input (Interlock)
2E	HA terminal (CN61) select	0000 : Usual 0002 : Fire alarm input 0001 : Leaving-ON prevention control	0000 : Usual (HA terminal)
31	Ventilating fan control	0000 : Unavailable 0001 : Available	0000 : Unavailable
32	TA sensor selection	0000 : Body TA sensor 0001 : Remote controller sensor	0000 : Body TA sensor
33	Temperature unit select	0000 : °C (at factory shipment) 0001 : °F	0000 : °C

TYPE

Item code [10]

Setup data	Type	Abbreviated Model name
0018	Console	MML-AP XXX 4NH

Indoor unit capacity

Item code [11]

Setup data	Model
0001	007
0003	009
0005	012
0007	015
0009	018

9-1-2. Applied Control in Indoor Unit

■ Remote location ON/OFF control box (TCB-IFCB-4E2)

[Wiring and setup]

- Use the exclusive connector for connection with the indoor control P.C. board.
- In a group control, the system can operate when connecting with any indoor unit (Control P.C. board) in the group. However when taking out the operation/error signal from the other unit, it is necessary to take out from each unit individually.

(1) Control items

- 1) Start/Stop input signal : Operation start/stop in unit
- 2) Operation signal : Output during normal operation
- 3) Error signal : Output during alarm
(Serial communication error or indoor/outdoor protective device) operation

(2) Wiring diagram using remote control interface (TCB-IFCB-4E2)

- Input IFCB-4E2 : No voltage ON/OFF serial signal
- Output No voltage contact for operation, error display
Contact capacity: Below Max. AC240V 0.5A

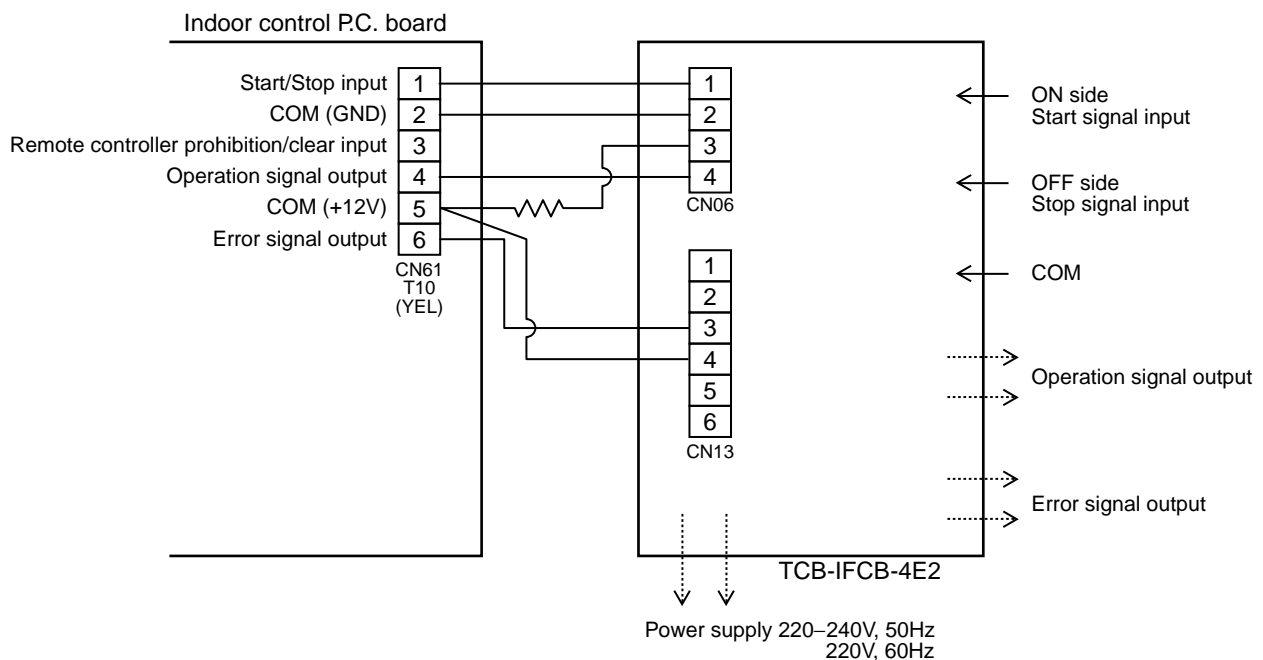

■ Ventilating fan control from remote controller

[Function]

- The start/stop operation can be operated from the wired remote controller when air to air heat exchanger or ventilating fan is installed in the system.
- The fan can be operated even if the indoor unit is not operating.
- Use a fan which can receive the no-voltage A contact as an outside input signal.
- In a group control, the units are collectively operated and they can not be individually operated.

1. Operation

Handle a wired remote controller in the following procedure.

- * Use the wired remote controller during stop of the system.
- * Be sure to set up the wired remote controller to the header unit. (Same in group control)
- * In a group control, if the wired remote controller is set up to the header unit, both header and follower units are simultaneously operable.

1 Push concurrently + + buttons for 4 seconds or more.

The unit No. displayed firstly indicates the header indoor unit address in the group control.
In this time, the fan of the selected indoor unit turns on.

2 Every pushing button, the indoor unit numbers in group control are displayed successively.

In this time, the fan of the selected indoor unit only turns on.

3 Using the setup temp or button, specify the item code **31**.

4 Using the timer time or button, select the setup data. (At shipment: *0000*)

The setup data are as follows:

Setup data	Handling of operation of air to air heat exchanger or ventilating fan
<i>0000</i>	Unavailable (At shipment)
<i>0001</i>	Available

5 Push button. (OK if display goes on.)

- To change the selected indoor unit, go to the **procedure 2**).
- To change the item to be set up, go to the **procedure 3**).

6 Pushing returns the status to the usual stop status.

2. Wiring

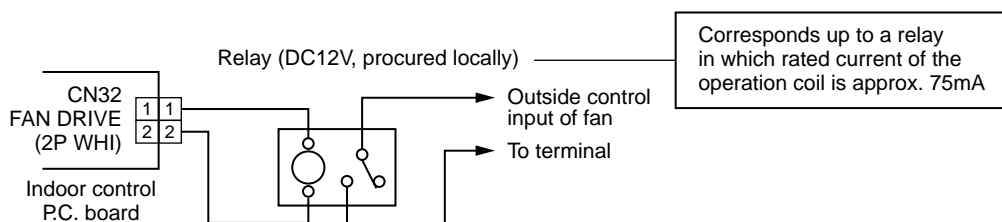

Note) Determine the cable length between the indoor control P.C. board and the relay within 2m.

■ Leaving-ON prevention control

[Function]

- This function controls the indoor units individually. It is connected with cable to the control P.C. board of the indoor unit.
- In a group control, it is connected with cable to the indoor unit (Control P.C. board), and the item code 2E is set to the connected indoor unit.
- It is used when the start operation from outside if unnecessary but the stop operation is necessary.
- Using a card switch box, card lock, etc, the forgotten-OFF of the indoor unit can be protected.
- When inserting a card, start/stop operation from the remote controller is allowed.
- When taking out a card, the system stops if the indoor unit is operating and start/stop operation from the remote controller is forbidden.









1. Control items

- 1) Outside contact ON : The start/stop operation from the remote controller is allowed.
(Status that card is inserted in the card switch box)
 - 2) Outside contact OFF : If the indoor unit is operating, it is stopped forcedly.
(Start/Stop prohibited to remote controller)
(Status that card is taken out from the card switch box)
- * When the card switch box does not perform the above contact operation, convert it using a relay with b contact.

2. Operation

Handle the wired remote controller switch in the following procedure.

- * Use the wired remote controller switch during stop of the system.

- 1 Push concurrently  +  +  buttons for 4 seconds or more.
- 2 Using the setup temp  or  button, specify the item code *2E*.
- 3 Using the timer time  or  button, set *0001* to the setup data.
- 4 Push  button.
- 5 Push  button. (The status returns to the usual stop status.)

3. Wiring

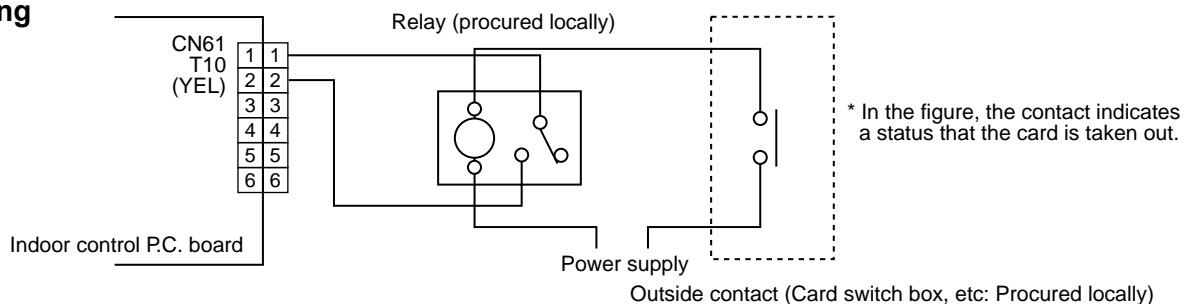

Note) Determine the cable length between the indoor control P.C. board and the relay within 2m.

■ Power peak-cut from indoor unit

When the relay is turned on, a forced thermostat-OFF operation starts.

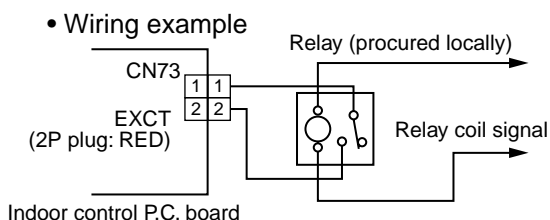

Note) Determine the cable length between the indoor or outdoor control P.C. board and the relay within 2m.

■ Address setup (Manual setting from Wired remote controller)

In case that addresses of the indoor units will be determined prior to piping work after wiring work

- Set an indoor unit per a remote controller.
- Turn on power supply.

- 1** Push **SET** + **CL** + **TEST** buttons simultaneously for 4 seconds or more.
- 2** (Line address)
Using the temperature setup **▼** / **▲** buttons, set **1** to the CODE No.
- 3** Using timer time **▼** / **▲** buttons, set the line address.
- 4** Push **SET** button. (OK when display goes on.)
- 5** (Indoor unit address)
Using the temperature setup **▼** / **▲** buttons, set **1** to the CODE No.
- 6** Using timer time **▼** / **▲** buttons, set **1** to the line address.
- 7** Push **SET** button. (OK when display goes on.)
- 8** (Group address)
Using the temperature setup **▼** / **▲** buttons, set **1** to the CODE No.
- 9** Using timer time **▼** / **▲** buttons, set **0000** to Individual, **0001** to Header unit and **0002** to follower unit.
- 10** Push **SET** button. (OK when display goes on.)
- 11** Push **TEST** button.
Setup completes.
(The status returns to the usual stop status.)

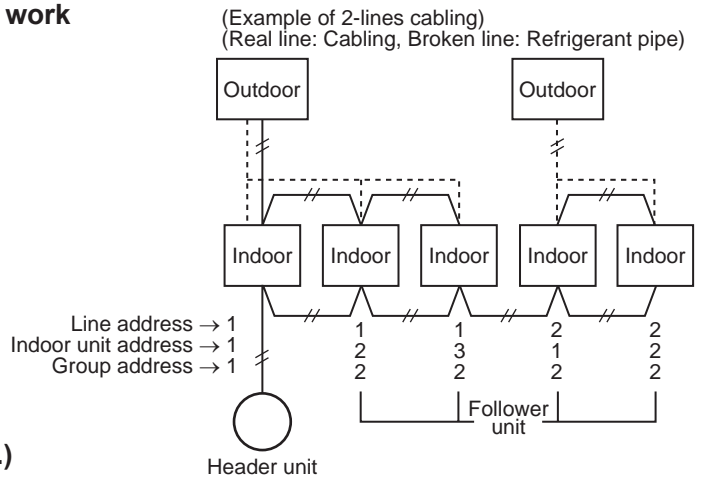

For the above example, perform setting by connecting singly the wired remote controller without remote controller inter-unit cable.

Group address
Individual : 0000
Header unit : 0001
Follower unit : 0002 } In case of group control

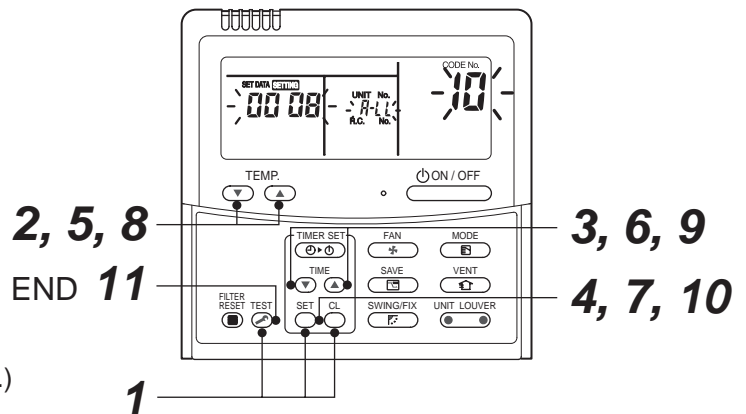

<Operation procedure>

**1 → 2 → 3 → 4 → 5 → 6 →
7 → 8 → 9 → 10 → 11 END**

Note 1)

When setting the line address from the remote controller, do not use Address 29 and 30.

As they are addresses which cannot be set to the outdoor unit, if they are set, the check code [E04] (Indoor/Outdoor communication circuit error) is issued.

Note 2)

When an address was manually set from the remote controller and the central control over the refrigerant lines is carried out, perform the following setting for the Header unit of each line.

- Set the line address for every line using SW13 and 14 on the interface P.C. board of the Header unit in each line.
- Except the least line address No., turn off SW30-2 on the interface P.C. board of the Header units in the lines connected to the identical central control.
(Draw the terminal resistances of indoor/outdoor and central control line wirings together.)
- For each refrigerant line, connect the relay connector between Header unit [U1U2] and [U3U4] terminals.
- After then set the central control address.
(For setting of the central control address, refer to the Installation manual for the central remote controller.)

■ Confirmation of indoor unit No. position

1. To know the indoor unit addresses though position of the indoor unit is recognized

- In case of individual operation (Wired remote controller : indoor unit = 1 : 1)
(Follow to the procedure during operation)

<Procedure>

1 Push  button if the unit stops.

2 Push  button (button at left side).

Unit No. 1-1 is displayed on LCD.

(It disappears after several seconds.)

The displayed unit No. indicate line address and indoor unit address.

(When other indoor units are connected to the identical remote controller (Group control unit), other unit numbers are also displayed every pushing  button (button at left side).

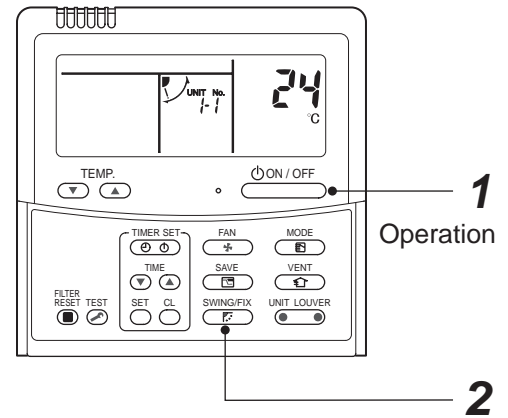

<Operation procedure>



1 → 2 END

2. To know the position of indoor unit by address

- To confirm the unit No. in the group control
(Follow to the procedure during operation) (in this procedure, the indoor units in group control stop.)

<Procedure>

The indoor unit numbers in the group control are successively displayed, and fan, louver, and drain pump of the corresponding indoor unit are turned on.
(Follow to the procedure during operation)

1 Push  and  buttons simultaneously for 4 seconds or more.

- Unit No. **ALL** is displayed.
- Fans and louvers of all the indoor units in the group control operate.

2 Every pushing  button (button at left side), the unit numbers in the group control are successively displayed.

- The unit No. displayed at the first time indicates the header unit address.
- Fan and louver of the selected indoor unit only operate.

3 Push  button to finish the procedure.
All the indoor units in the group control stop.

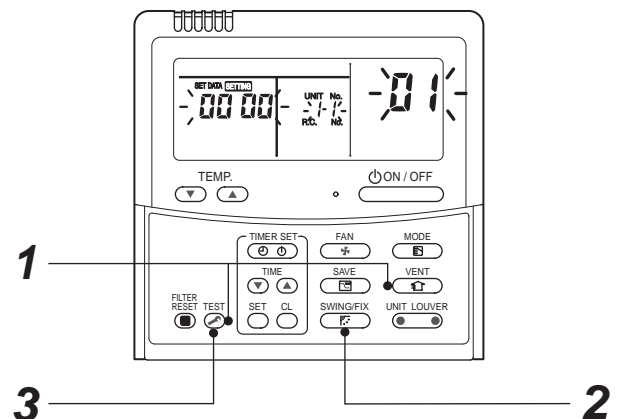

<Operation procedure>

1 → 2 → 3 END

■ Function selection setup

<Procedure> Perform setting while the air conditioner stops.

1 Push **TEST** + **SET** + **CL** buttons simultaneously for 4 seconds or more.

The first displayed unit No. is the master indoor unit address in the group control.

In this time, fan and louver of the selected indoor unit operate.



2 Every pushing **UNIT LOUVER** button (button at left side), the indoor unit No. in the group control is displayed one after the other.

In this time, fan and louver of the selected indoor unit only operate.



3 Using the set temperature **TEMP.** buttons, specify the CODE No. (DN).



4 Using the timer time **TIME** buttons, select the set data.



5 Push **SET** button. (OK if indication lights)

- To change the selected indoor unit, proceed to Procedure **2**.
- To change item to be set up, proceed to Procedure **3**.



6 Pushing **TEST** button returns the status to the normal stop status.

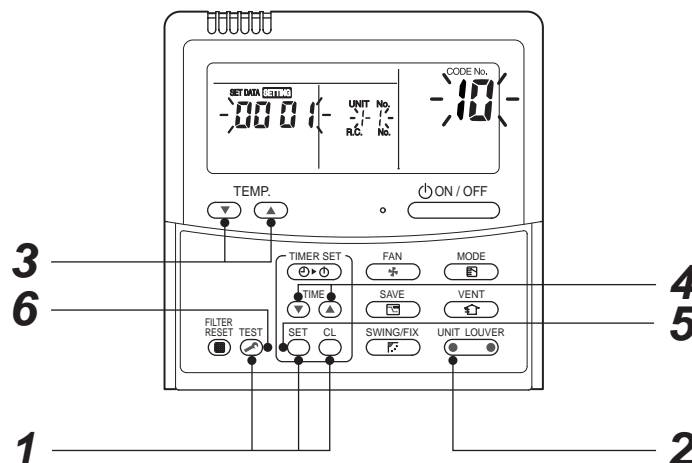

<Operation procedure>

1 → 2 → 3 → 4 → 5 → 6 END

■ How to check all the unit No. from an arbitrary wired remote controller

<Procedure> Carry out this procedure during stop of system.

The indoor unit No. and the position in the identical refrigerant piping can be checked.

An outdoor unit is selected, the identical refrigerant piping and the indoor unit No. are displayed one after the other, and then its fan and louver are on.

- 1 Push the timer time button + simultaneously for 4 seconds or more.
First line 1 and CODE No. **AL** (Address Change) are displayed. (Select outdoor unit.)



- 2 Select line address using / button.



- 3 Determine the selected line address using button.

- The address of the indoor unit connected to the refrigerant piping of the selected outdoor unit is displayed and the fan and the louver are on.



- 4 Every pushing button (button at left side), the indoor unit No. in the identical piping is displayed one after the other.

- Only fan and louver of the selected indoor unit start operation.

[To select the other line address]

- 5 Push button and the operation returns to Procedure 2.

- * The indoor address of other line can be continuously checked.



- 6 Push button and then the procedure finishes.

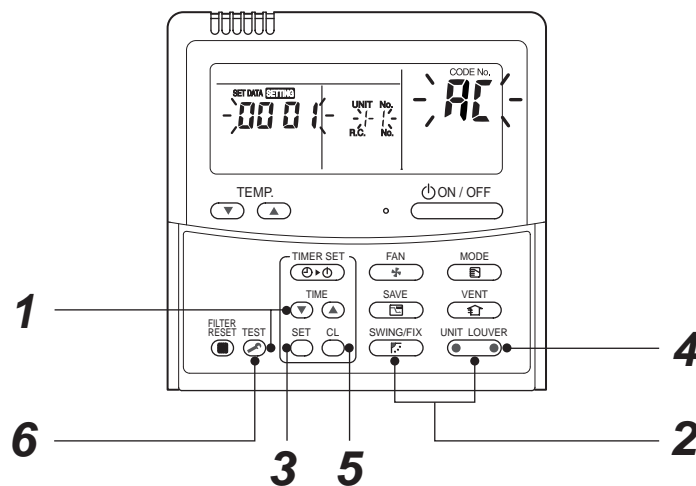

<Operation procedure>

1 → 2 → 3 → 4 → 5 → 6 END

■ How to change all indoor addresses from an arbitrary wired remote controller

(It is possible when setting has finished by automatic addresses.)

Contents: The indoor unit addresses in each identical refrigerant piping line can be changed from an arbitrary wired remote controller.

⊙ Enter in address check/change mode and then change the address.

<Procedure> Carry out this procedure during stop of system.

- 1 Push the timer time button (▼) + TEST simultaneously for 4 seconds or more. First line 1 and CODE No. *AC* (Address Change) are displayed.



- 2 Select line address using UNIT LOUVER / SWING/FIX button.



- 3 Push the SET button.

- The address of the indoor unit connected to the refrigerant piping of the selected outdoor unit is displayed and the fan and the louver are on.

First the current indoor address is displayed. (Line address is not displayed.)



- 4 TIME button push up/down the indoor address of the SET DATA.

The set data is changed to a new address.



- 5 Push SET button to determine the set data.



- 6 Every pushing UNIT LOUVER button (button at left side), the indoor unit No. in the identical piping is displayed one after the other.

- Only fan and louver of the selected indoor unit start operation.

Repeat the Procedures 4 to 6 to change all the indoor addresses so that they are not duplicated.



- 7 Push SET button. (All the indications of LCD go on.)



- 8 Push TEST button and then the procedure finishes.

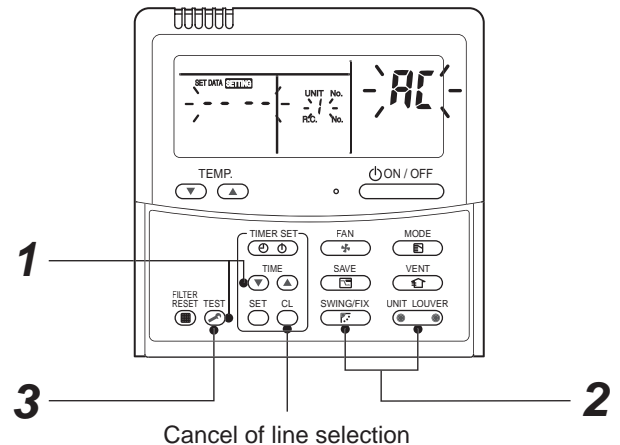

If the UNIT No. is not call up here, the outdoor unit in that line does not exist.

Push CL button to select a line again in the Procedure 2.

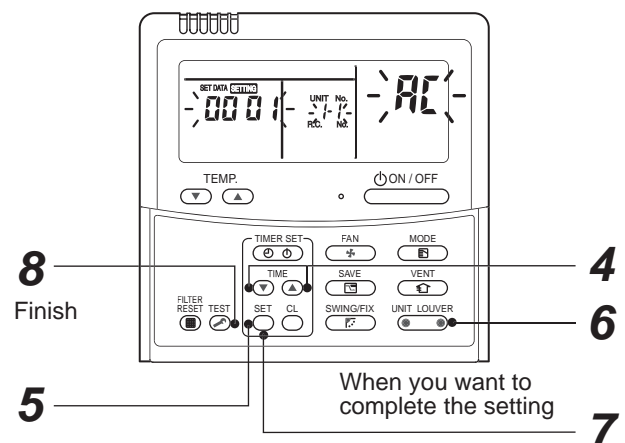

<Operation procedure>

1 → 2 → 3 → 4 → 5 →
6 → 7 → 8 END

■ Function to clear error

1. Clearing method from remote controller

⊙ How to clear error of outdoor unit

In the unit of refrigerant line connected by indoor unit of the remote controller to be operated, the error of the outdoor unit currently detected is cleared. (Error of the indoor unit is not cleared.)

The service monitor function of the remote controller is utilized.

<Method>

- 1** Push **CL** + **TEST** buttons simultaneously for 4 seconds or more to change the mode to service monitor mode.
- 2** Push **TEMP.** button to set the CODE No. to [FF].
- 3** The display of A part in the following figure is counted as "0005" → "0004" → "0003" → "0002" → "0001" → "0000" with 5-seconds interval.
When "0000" appear, the error was cleared.
* However counting from "0005" is repeated on the display screen.
- 4** When pushing **TEST** button, the status becomes normal.

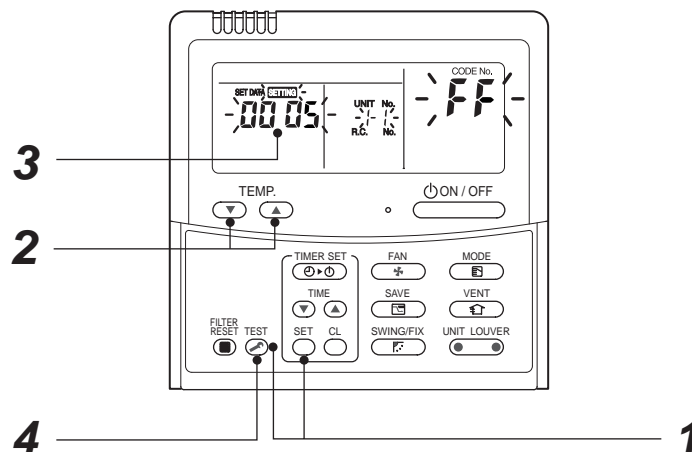

<Operation procedure>

1 → 2 → 3 → 4

Returns to normal status

⊙ How to clear error of indoor unit

The error of indoor unit is cleared by **ON/OFF** button of the remote controller.

(Only error of the indoor unit connected with remote controller to be operated is cleared.)

■ Monitoring function of remote controller switch

When using the remote controller (Model Name: RBC-AMT32E), the following monitoring function can be utilized.

Calling of display

<Contents>

The temperature of each sensor of the remote controller, indoor unit and outdoor unit and the operating status can be checked by calling the service monitor mode from the remote controller.

<Procedure>

- 1 Push **TEST** + **CL** buttons simultaneously for 4 seconds or more to call up the service monitor mode. The service monitor goes on and firstly the temperature of the CODE No. **00** is displayed.



- 2 Push **TEMP.** button to change CODE No. to the CODE No. to be monitored. For display code, refer to the following table.



- 3 Push **UNIT LOUVER** button to change to CODE No. to be monitored. The sensor temperature of indoor unit or outdoor unit in its refrigerant line and the operating status are monitored.



- 4 Push **TEST** button to return the status to the normal display.

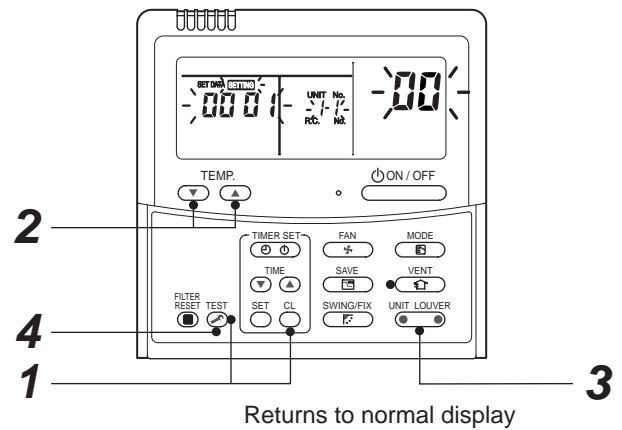

Returns to normal display

<Operation procedure>

1 → 2 → 3 → 4

	CODE No.	Data name	Unit	Display form	CODE No.	Data name	Unit	Display form
Indoor unit data	00	Room temp. (Under control) (Note 1)	°C	x 1	Individual outdoor unit data (Note 3, 4)	10	Compressor 1 discharge temp. (Td1)	°C x 1
	01	Room temp. (Remote controller)	°C	x 1		11	Compressor 2 discharge temp. (Td2)	°C x 1
	02	Indoor suction temp. (TA)	°C	x 1		12	High pressure sensor detection pressure (Pd)	MPa x 100
	03	Indoor coil temp. (TCJ)	°C	x 1		13	Low pressure sensor detection pressure (Ps)	MPa x 100
	04	Indoor coil temp. (TC2)	°C	x 1		14	Suction temp. (TS)	°C x 1
	05	Indoor coil temp. (TC1)	°C	x 1		15	Outdoor coil temp. (TE)	°C x 1
	08	Indoor PMV opening degree	pls	x 1/10		16	Liquid side temp. (TL)	°C x 1
	F2	Indoor fan accumulated operation time	h	x 100		17	Outside temp. (TO)	°C x 1
	F3	Filter sign time	h	x 1		18	Low pressure saturation temp. (TU)	°C x 1
	0A	No. of connected indoor units	unit			19	Compressor 1 current (I1)	A x 10
System data	0B	Total HP of connected indoor units	HP	x 10		1A	Compressor 2 current (I2)	A x 10
	0C	No. of connected outdoor units	unit			1B	PMV1 + 2 opening degree	pls x 1/10
	0D	Total HP of connected outdoor units	HP	x 10		1D	Compressor 1, 2 ON/OFF	— (Note 2)
						1E	Outdoor fan mode	— 0 to 31
						1F	Outdoor unit HP	HP x 1

(Note 1) In the group connection, only data of the header indoor unit is displayed.

(Note 2) 01: Only compressor 1 is ON.
10: Only compressor 2 is ON.
11: Both compressor 1 and 2 are ON.

(Note 3) For the CODE No., an example of header unit is described.

(Note 4) Upper girder of CODE No. indicates the outdoor unit No.

1: Header unit (A)
2: Follower unit (B)
3: Follower unit (C)
4: Follower unit (D)

10. TROUBLESHOOTING

10-1. Troubleshooting Summary

1. Before troubleshooting

1) Applied models

① S-MMS Multi type models

Indoor unit : MMX-APXXX,

Outdoor unit : MMY-MAPXXXXT8X, MMY-MAPXXXHT7X

② Super Heat Recovery Multi type models

Indoor unit : MMX-APXXX,

Outdoor unit : MMY-MAPXXXFT8X

③ Mini-S-MMS Multi type models

Indoor unit : MMX-APXXX,

Outdoor unit : MCY-MAPXXXHT, MCY-MAPXXXHT2X

2) Required tools / measuring devices

- Screwdrivers (Philips, Minus), spanner, radio pinchers, nipper, push pin for reset switch, etc.
- Tester, thermometer, pressure gauge, etc.

3) Confirmation before check (The following items are not troubles.)

No.	Operation	Check items
1	Compressor does not operate.	<ul style="list-style-type: none"> • Is not delayed for 3 minutes? (3 minutes after compressor-OFF) • Is not thermostat OFF? • Is not the fan operating or timer? • Is not the system initially communicating? Heating operation cannot be performed under condition of outside temperature 21°C or higher. Cooling operation cannot be performed under condition of outside temperature -5°C or lower.
2	Indoor fan does not work.	<ul style="list-style-type: none"> • Is not the cold draft prevention being controlled in heating operation?
3	Outdoor fan does not rotate, or fan speed changes.	<ul style="list-style-type: none"> • Is not low cooling operation being controlled? • Is not a defrost operation being performed?
4	Indoor fan does not stop.	<ul style="list-style-type: none"> • Is not after-heat elimination operation being controlled after heating operation?
5	Start/stop operation on remote controller is unavailable.	<ul style="list-style-type: none"> • Is not auxiliary unit or remote control being operated?
6	—	<ul style="list-style-type: none"> • Is connecting wire of indoor unit or remote controller correct?

2. Troubleshooting procedure

When a trouble occurred, advance the check operation in the following procedure.

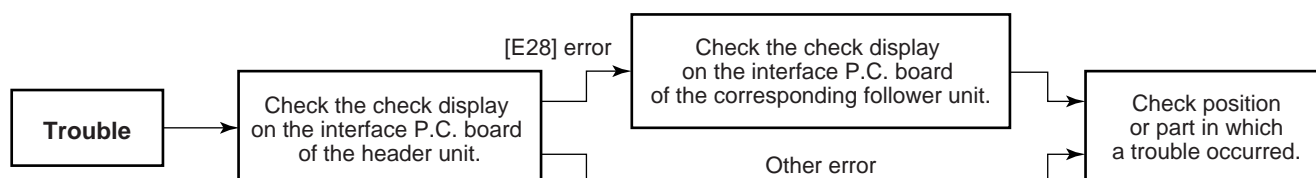

NOTE

While a check operation is performed, a malfunction of the microprocessor may be caused due to condition of the power supply or the external noise.

If there is any noise source, change wires of the remote controller and signal wires to shield wires.

10-2. How to check

On the remote controller (Remote controller, Central control remote controller) and on the interface P.C. board of the outdoor unit, LCD display part (Remote controller) or 7-segment display part (on outdoor interface P.C. board) is provided in order to display the operation status.

When a trouble occurred, the method to judge the trouble or defective position of the air conditioner by this self-diagnosis function is shown below.

The following table shows the list of each check code that each device detects. Check the check contents in the following table according to position to be checked.

- Check from the indoor remote controller or TCC-LINK central controller: Refer to “Display on remote controller & TCC-LINK central controller” in the following table.
- Check from outdoor unit: Refer to “Display of outdoor segment” in the following table.
- Check from indoor unit of wireless remote controller: Refer to Sensor lamp display” in the following table.

Check code display list (Indoor unit)

(*) O: Goes on, ◎: Flashes, ●: Goes off
 A (Alternate) : Flashing condition is alternate when there are two flashing LED.
 S (Simultaneously) : Two LED flash simultaneously when there are two flashing LED.

[Indoor unit detects error.]

Check code display		Sensor lamp display				Main defective position	Description	
TCC-LINK central & remote controller	Outdoor 7-segment	Block display (*)						
	Auxiliary code	Operation	Timer	Ready	Flash			
E03	—	—	◎	●	●	Regular communication error between indoor and remote controller	No communication from remote controller and network adapter (No central control system communication also)	
E04	—	—	●	●	◎	Regular communication error between indoor and outdoor	No communication from outdoor unit	
E08	E08	Duplicated indoor unit No.	◎	●	●	Duplicated indoor address	An address same to self address was detected.	
E10	—	—	◎	●	●	Communication error between indoor MCU	Communication error between MCU of main motor microprocessors	
E18	—	—	◎	●	●	Regular communication error between header and follower in indoor unit	Regular communication between header and follower units in indoor unit was impossible.	
F01	—	—	◎	◎	●	A	Indoor heat exchanger temp. sensor (TCJ) error	Open/short of heat exchanger temp. sensor (TCJ) was detected.
F02	—	—	◎	◎	●	A	Indoor heat exchanger temp. sensor (TC2) error	Open/short of heat exchanger temp. sensor (TC2) was detected.
F03	—	—	◎	◎	●	A	Indoor heat exchanger temp. sensor (TC1) error	Open/short of heat exchanger temp. sensor (TC1) was detected.
F10	—	—	◎	◎	●	A	Room tem. Sensor (TA) error	Open/short of room temp. sensor (TA) was detected.
F11	—	—	◎	◎	●	A	Discharge air temp. sensor (TF) error.	Open/short of discharge air temp. sensor was detected.
F29	—	—	◎	◎	●	S	Indoor or other P.C. board error	Indoor EEPROM error (Other error may be detected.)
L03	—	—	◎	●	◎	S	Duplicated setting of header in indoor group	There were multiple header units in a group.
L07	—	—	◎	●	◎	S	There is group cable in individual indoor unit.	There is even an indoor unit connected to group in individual indoor unit.
L08	L08	—	◎	●	◎	S	Indoor group address is unset.	Indoor group address is unset. (Detected also at outdoor unit side)
L09	—	—	◎	●	◎	S	Indoor capacity is unset.	Capacity of indoor unit is unset.
L20	—	—	◎	○	◎	S	Duplicated central control system address	Setting of central control system address is duplicated.
L30	L30	Detected indoor unit No.	◎	○	◎	S	External error was input in indoor (Interlock).	System abnormally stopped by input of external error (CN80).
P01	—	—	●	◎	◎	A	Indoor AC fan error	Error of indoor AC fan was detected. (Fan motor thermal relay operation)
P10	P10	Detected indoor unit No.	●	◎	◎	A	Indoor overflow was detected.	Float switch operated.
P12	—	—	●	◎	◎	A	Indoor DC fan error	Error (Over-current, lock, etc.) of indoor DC fan was detected.
P31	—	—	◎	●	◎	A	Other indoor unit error	Group follower unit cannot be operated by [E03/L03/L07/L08] alarm of header unit.

Note) The check code display may be different according to the detected device even same error contents such as communication error.

[Remote controller detects error.]

(*) O: Goes on, ◎: Flashes, ●: Goes off
 A (Alternate) : Flashing condition is alternate when there are two flashing LED.
 S (Simultaneously) : Two LED flash simultaneously when there are two flashing LED.

Check code display			Sensor lamp display				Main defective position	Description
Remote controller	Outdoor 7-segment		Block display (*)					
	Auxiliary code		Operation	Timer	Ready	Flash		
E01	—	—	◎	●	●		No remote controller header unit, remote controller communication (receive) error	When signal cannot be received from indoor unit, when header of remote controller was not set (including 2 remote controllers)
E02	—	—	◎	●	●		Remote controller communication (send) error	When signal cannot be sent to indoor unit
E09	—	—	◎	●	●		Duplicated remote controller header	In 2-remote controller control, both remote controllers were set to header. (Indoor header stops with alarm and follower unit continues operation.)

[Central controller detects error.]

Check code display			Sensor lamp display				Main defective position	Description
TCC-LINK central	Outdoor 7-segment		Block display (*)					
	Auxiliary code		Operation	Timer	Ready	Flash		
C05	—	—	Is not displayed (In shared use of remote controller)				Central control system communication (send) error	When signal of central control system cannot be sent, there are same multiple central devices (AI-NET)
C06	—	—					Central control system communication (receive) error	When signal of central control system cannot be received
—	—	—					There are multiple network adapters.	There were multiple network adapters (AI-NET) on remote controller communication line.
C12	—	—					Batched alarm of interface for general-purpose equipment control	Error of equipment connected to control interface of the general-purpose unit exclusive to TCC-LINK/AI-NET
P30	—	—	According to unit with alarm (Abovementioned)				Group follower unit error	Group follower unit error (For remote controller, [***] details is displayed together with unit No.)

Note) The check code display may be different according to the detected device even same error contents such as communication error.

Check code display list (Outdoor unit)

(*) ○ : Goes on, ◎ : Flashes, ● : Goes off
 A (Alternate) : Flashing condition is alternate when there are two flashing LED.
 S (Simultaneously) : Two LED flash simultaneously when there are two flashing LED.

[SMMS-i interface detects error: Main example]

Check code display		TCC-LINK central & remote controllers	Sensor lamp display				Main defective position	Description																																																																																																
Outdoor 7-segment Auxiliary code			Block display																																																																																																					
		Operation				Timer	Ready	Flash																																																																																																
E06	No. of indoor units which received signal normally	E06	●	●	◎			Decrease of quantity of indoor units (Decrease of connected indoor units)																																																																																																
E07	—	(E04)	●	●	◎			Indoor/Outdoor communication circuit error Signal cannot be sent to indoor unit. (→There is no communication from outdoor unit.)																																																																																																
E08	Duplicated indoor unit number	(E08)	◎	●	●			Duplicated indoor address There are multiple indoor units having the same address. (Detected also at indoor unit side)																																																																																																
E12	01: Indoor/Outdoor communication 02: Communication between Outdoor units	E12	◎	●	●			Automatic address start error Automatic indoor address operation while setting automatic address of other system Outdoor automatic address operation while setting automatic indoor address																																																																																																
E15	—	E15	●	●	◎			There is none during auto addressing. There is no signal receiving from outdoor unit during automatic addressing.																																																																																																
E16	00: Capacity over 01 ~ : No. of connected units	E16	●	●	◎			No. of connected indoor units: Over capacity Total capacity of indoor units exceeded (total capacity of outdoor units × 135%)																																																																																																
E19	00: No center outdoor unit 02: 2 or more center outdoor units	E19	●	●	◎			No. of center outdoor units error There is no center outdoor unit or there are 2 or more outdoor units in 1 line.																																																																																																
E20	01: Connected to outdoor of other line 02: Connected to indoor of other line	E20	●	●	◎			Connected to other line during automatic addressing Indoor unit of other line was detected during automatic address is been setting.																																																																																																
E21	00: Duplicated header units 02: No header unit	E21	●	●	◎			Header heat unit quantity error There is no header heat unit in the system, or there are multiple header units.																																																																																																
E22	—	E22	●	●	◎			Decrease of heat unit quantity No communication from heat unit (Decrease of connected heat units)																																																																																																
E23	—	E23	●	●	◎			Send error communication between outdoor units Sending to other outdoor is unavailable.																																																																																																
E25	—	E25	●	●	◎			Duplicated terminal outdoor address setting Manually set outdoor address was duplicated.																																																																																																
E26	Receive error of outdoor address	E26	●	●	◎			Decrease of connected outdoor units No communication from terminal outdoor unit (Decrease of connected terminal outdoor units)																																																																																																
E28	Detected outdoor unit number	E28	●	●	◎			Terminal outdoor error Center outdoor unit detected terminal outdoor unit error. (For terminal outdoor unit, details are displayed.)																																																																																																
E31	<table border="1"> <thead> <tr> <th rowspan="2"></th> <th colspan="3">A3-IPDU</th> <th rowspan="2">FAN IPDU</th> <th colspan="3">A3-IPDU</th> <th rowspan="2">FAN IPDU</th> </tr> <tr> <th>1</th> <th>2</th> <th>3</th> <th>1</th> <th>2</th> <th>3</th> </tr> </thead> <tbody> <tr> <td>01</td> <td>○</td> <td></td> <td></td> <td>0A</td> <td>○</td> <td></td> <td></td> <td>○</td> </tr> <tr> <td>02</td> <td></td> <td>○</td> <td></td> <td>0B</td> <td>○</td> <td>○</td> <td></td> <td>○</td> </tr> <tr> <td>03</td> <td>○</td> <td>○</td> <td></td> <td>0C</td> <td></td> <td></td> <td>○</td> <td>○</td> </tr> <tr> <td>04</td> <td></td> <td></td> <td>○</td> <td>0D</td> <td>○</td> <td></td> <td>○</td> <td>○</td> </tr> <tr> <td>05</td> <td>○</td> <td>○</td> <td>○</td> <td>0E</td> <td></td> <td>○</td> <td>○</td> <td>○</td> </tr> <tr> <td>06</td> <td></td> <td>○</td> <td>○</td> <td>0F</td> <td>○</td> <td>○</td> <td>○</td> <td>○</td> </tr> <tr> <td>07</td> <td>○</td> <td>○</td> <td>○</td> <td></td> <td></td> <td></td> <td></td> <td></td> </tr> <tr> <td>08</td> <td></td> <td></td> <td></td> <td>○</td> <td></td> <td></td> <td></td> <td></td> </tr> <tr> <td>09</td> <td>○</td> <td></td> <td></td> <td>○</td> <td></td> <td></td> <td></td> <td></td> </tr> </tbody> </table> <p>○ mark: Error position.</p>		A3-IPDU			FAN IPDU	A3-IPDU			FAN IPDU	1	2	3	1	2	3	01	○			0A	○			○	02		○		0B	○	○		○	03	○	○		0C			○	○	04			○	0D	○		○	○	05	○	○	○	0E		○	○	○	06		○	○	0F	○	○	○	○	07	○	○	○						08				○					09	○			○					E31	●	●	◎			IPDU communication error No communication of each IPDU (P.C. board) in inverter box
	A3-IPDU			FAN IPDU	A3-IPDU			FAN IPDU																																																																																																
	1	2	3		1	2	3																																																																																																	
01	○			0A	○			○																																																																																																
02		○		0B	○	○		○																																																																																																
03	○	○		0C			○	○																																																																																																
04			○	0D	○		○	○																																																																																																
05	○	○	○	0E		○	○	○																																																																																																
06		○	○	0F	○	○	○	○																																																																																																
07	○	○	○																																																																																																					
08				○																																																																																																				
09	○			○																																																																																																				
F04	—	F04	◎	◎	○		A	Outdoor discharge temp. sensor (TD1) error Open/Short of outdoor discharge temp. sensor (TD1) was detected.																																																																																																
F05	—	F05	◎	◎	○		A	Outdoor discharge temp. sensor (TD2) error Open/Short of outdoor discharge temp. sensor (TD2) was detected.																																																																																																
F06	01: TE1 02: TE2	F06	◎	◎	○		A	Outdoor heat exchanger temp. sensor (TE1, TE2) error Open/Short of heat exchanger temp. sensor (TE1, TE2) was detected.																																																																																																
F07	—	F07	◎	◎	○		A	Outdoor liquid temp. sensor (TL) error Open/Short of outdoor liquid temp. sensor (TL) was detected.																																																																																																
F08	—	F08	◎	◎	○		A	Outdoor outer air temp. sensor (TO) error Open/Short of outer air temp. sensor (TO) was detected.																																																																																																
F11	—	F11	—	—	—			—																																																																																																
F12	—	F12	◎	◎	○		A	Outdoor suction temp. sensor (TS1) error Open/Short of outdoor suction temp. sensor (TS1) was detected.																																																																																																
F15	—	F15	◎	◎	○		A	Outdoor temp. sensor (TE1, TL) miswiring Miswiring by temp. sensor (TE1, TL) was detected.																																																																																																
F16	—	F16	◎	◎	○		A	Outdoor pressure sensor (Pd, Ps) miswiring Miswiring by outdoor pressure sensor (Pd, Ps) was detected.																																																																																																
F22	—	F22	◎	◎	○		A	Outdoor discharge temp. sensor (TD3) error Open/Short of outdoor discharge temp. sensor (TD3) was detected.																																																																																																
F23	—	F23	◎	◎	○		A	Low pressure (Ps) sensor error Output voltage of low pressure (Ps) sensor detected 0.																																																																																																
F24	—	F24	◎	◎	○		A	High pressure (Pd) sensor error Output voltage of high pressure (Pd) sensor detected 0 or error value was detected during stop of compressor.																																																																																																
F31	—	F31	◎	◎	○		S	Outdoor EEPROM error Outdoor EEPROM error (Center unit stops alarm and terminal unit continues operation.)																																																																																																

(*) ○: Goes on, ◎: Flashes, ●: Goes off
 A (Alternate) : Flashing condition is alternate when there are two flashing LED.
 S (Simultaneously) : Two LED flash simultaneously when there are two flashing LED.

Check code display		TCC-LINK central & remote controllers	Sensor lamp display				Main defective position	Description																																																																																								
Outdoor 7-segment Auxiliary code			Block display																																																																																													
		Operation Timer Ready Flash																																																																																														
H05	—	H05	●	◎	●		Outdoor discharge temp. sensor (TD1) miswiring	Miswiring or mismounting of outdoor discharge temp. sensor (TD1) or coming-out of TD1 sensor was detected.																																																																																								
H15	—	H15	●	◎	●		Outdoor discharge temp. sensor (TD2) miswiring	Miswiring or mismounting of outdoor discharge temp. sensor (TD2) or coming-out of TD2 sensor was detected.																																																																																								
H25	—	H25	●	◎	●		Outdoor discharge temp. sensor (TD3) miswiring	Miswiring or mismounting of outdoor discharge temp. sensor (TD3) or coming-out of TD3 sensor was detected.																																																																																								
H06	—	H06	●	◎	●		Low pressure protective operation	Protection by low pressure (Ps) sensor was detected.																																																																																								
H07	—	H07	●	◎	●		Protection for oil level drop	Protection detection by temp. sensor (TK1 to 5) for oil level detection.																																																																																								
H08	01: TK1 sensor error 02: TK2 sensor error 03: TK3 sensor error 04: TK4 sensor error 05: TK5 sensor error	H08	●	◎	●		Oil level detection temp. sensor (TK1 to 5) error	Open/Short of temp. sensor (TK1 to 5) for oil level detection was detected.																																																																																								
H16	01: TK1 Oil circuit system error 02: TK2 Oil circuit system error 03: TK3 Oil circuit system error 04: TK4 Oil circuit system error 05: TK5 Oil circuit system error	H16	●	◎	●		Detection circuit error	After starting compressor operation, temperature change of temp. sensor (TK1 to 5) for oil level detection was not detected.																																																																																								
L04	—	L04	◎	○	◎	S	Duplicated outdoor system address	Duplicated setting of system address to outdoor units of different refrigerant piping system																																																																																								
L06	No. of preceded indoor units (L05/L06) by individual display)	L05	◎	●	◎	S	Duplicated priority indoor units (Displayed in priority indoor unit)	Duplicated priority indoor units (For priority indoor unit)																																																																																								
		L06	◎	●	◎	S	Duplicated priority indoor units (Displayed except priority indoor unit)	Duplicated priority indoor units (For indoor units without priority)																																																																																								
L08	—	L08	◎	●	◎	S	Unset indoor group address	There is indoor unit which indoor group address was not set (Detected also at indoor unit side)																																																																																								
L10	—	L10	◎	○	◎	S	Unset outdoor unit capacity	Capacity of outdoor unit is not set. (Exchange service P.C. board.)																																																																																								
L17	—	L17	◎	○	◎	S	Disagreed error of outdoor model	Former model of outdoor unit (Before 3 series) was connected.																																																																																								
L18	—	L18	◎	○	◎	S	Refrigerant change unit system error	COOL/HEAT cycle error by mispiping, etc was detected.																																																																																								
L26	No. of connected heat units	L26	◎	○	◎	S	No. of connected heat unit over	There are 3 or more connected heat units.																																																																																								
L27	No. of connected heat units	L27	◎	○	◎	S	No. of connected heat unit error	Heat unit was not connected, or combination of No. of outdoor units with No. of heat units defective.																																																																																								
L28	—	L28	◎	○	◎	S	No. of connected outdoor units over	No. of connected outdoor units exceeded 4 units																																																																																								
L29	<table border="1"> <thead> <tr> <th rowspan="2"></th> <th colspan="3">A3-IPDU</th> <th rowspan="2">FAN IPDU</th> <th colspan="3">A3-IPDU</th> <th rowspan="2">FAN IPDU</th> </tr> <tr> <th>1</th> <th>2</th> <th>3</th> <th>1</th> <th>2</th> <th>3</th> </tr> </thead> <tbody> <tr> <td>01</td> <td>○</td> <td></td> <td></td> <td>0A</td> <td>○</td> <td></td> <td>○</td> </tr> <tr> <td>02</td> <td></td> <td>○</td> <td></td> <td>0B</td> <td>○</td> <td>○</td> <td>○</td> </tr> <tr> <td>03</td> <td>○</td> <td>○</td> <td></td> <td>0C</td> <td></td> <td>○</td> <td>○</td> </tr> <tr> <td>04</td> <td></td> <td></td> <td>○</td> <td>0D</td> <td>○</td> <td>○</td> <td>○</td> </tr> <tr> <td>05</td> <td>○</td> <td>○</td> <td>○</td> <td>0E</td> <td>○</td> <td>○</td> <td>○</td> </tr> <tr> <td>06</td> <td></td> <td>○</td> <td>○</td> <td>0F</td> <td>○</td> <td>○</td> <td>○</td> </tr> <tr> <td>07</td> <td>○</td> <td>○</td> <td>○</td> <td></td> <td></td> <td></td> <td></td> </tr> <tr> <td>08</td> <td></td> <td></td> <td></td> <td>○</td> <td></td> <td></td> <td></td> </tr> <tr> <td>09</td> <td>○</td> <td></td> <td></td> <td>○</td> <td></td> <td></td> <td></td> </tr> </tbody> </table> <p>○ mark: Error position.</p>			A3-IPDU			FAN IPDU	A3-IPDU			FAN IPDU	1	2	3	1	2	3	01	○			0A	○		○	02		○		0B	○	○	○	03	○	○		0C		○	○	04			○	0D	○	○	○	05	○	○	○	0E	○	○	○	06		○	○	0F	○	○	○	07	○	○	○					08				○				09	○			○				L29	◎	○	◎	S	IPDU quantity error	No. of IPDU (P.C. board) in inverter box is few.
		A3-IPDU			FAN IPDU	A3-IPDU			FAN IPDU																																																																																							
		1	2	3		1	2	3																																																																																								
	01	○			0A	○		○																																																																																								
	02		○		0B	○	○	○																																																																																								
	03	○	○		0C		○	○																																																																																								
	04			○	0D	○	○	○																																																																																								
	05	○	○	○	0E	○	○	○																																																																																								
	06		○	○	0F	○	○	○																																																																																								
	07	○	○	○																																																																																												
08				○																																																																																												
09	○			○																																																																																												
L30	Detection of indoor unit number	(L30)	◎	○	◎	S	Outside error input in indoor (Interlock)	There is indoor unit which abnormally stops by outer error input in 1 system. (← Indoor unit detected.)																																																																																								
P03	—	P03	◎	●	◎	A	Outdoor unit discharge (TD1) temp. error	High temp. error was detected at outdoor discharge temp. sensor (TD1).																																																																																								
P05	00: Open phase shortage detection	P05	◎	●	◎	A	Open phase shortage: Power failure error	When power supply was turned on, open phase shortage was detected.																																																																																								
	Inverter DC voltage (Vdc) error						Over current/Current shortage was detected at inverter DC voltage.																																																																																									

(*) ○: Goes on, ◎: Flashes, ●: Goes off
 A (Alternate) : Flashing condition is alternate when there are two flashing LED.
 S (Simultaneously) : Two LED flash simultaneously when there are two flashing LED.

Check code display		TCC-LINK central & remote controllers	Sensor lamp display			Main defective position	Description
Outdoor 7-segment	Auxiliary code		Block display				
			Operation	Timer	Ready	Flash	
P07	01: Compressor 1 side 02: Compressor 2 side 03: Compressor 3 side	P07	◎	●	◎	A	Heat sink overheat error High temp. error was detected in outdoor IGBT built-in temp. sensor (TH).
P09	Detection of heat unit number	(P09)	●	◎	◎	A	Heat unit water-shortage error There is heat unit which was been detected water-shortage in 1 system. (← Heat unit detected.)
P10	Detection of indoor unit number	(P10)	●	◎	◎	A	There is indoor unit which overflow was detected. There is abnormally stopped indoor unit which was been detected water-overflow in 1 system. (← Indoor unit detected.)
P13	—	P13	●	◎	◎	A	Outdoor liquid back detection error Liquid back operation was judged from refrigerant cycle status.
P15	01: TS condition 02: TD condition	P15	◎	●	◎	A	Gas leak detection Outdoor suction temp. sensor (TS1) continuously and repeatedly detected high temperature over standard value.
P17	—	P17	◎	●	◎	A	Outdoor discharge (TD2) temp. error High temp. error was detected in outdoor discharge temp. sensor (TD2).
P18	—	P18	◎	●	◎	A	Outdoor discharge (TD3) temp. error High temp. error was detected in outdoor discharge temp. sensor (TD3).
P19	Detection of outdoor unit number	P19	◎	●	◎	A	4-way valve invert error Refrigerant cycle error was detected in heating operation.
P20	—	P20	◎	●	◎	A	High pressure protection operation High pressure (Pd) sensor detected pressure over standard value.
P24	Detection of heat unit number	P24	◎	●	◎	A	Heat unit error (Main code) Heat unit detected error (Heat remote controller displays detailed check code together with model number.)

Check code display list (Outdoor unit)

(*) ○: Goes on, ◎: Flashes, ●: Goes off
 A (Alternate) : Flashing condition is alternate when there are two flashing LED.
 S (Simultaneously) : Two LED flash simultaneously when there are two flashing LED.

[SMMS-i unit IPDU detects error: Main example]

Check code display			Sensor lamp display				Main defective position	Description
Outdoor 7-segment		TCC-LINK central & remote controllers	Block display					
Auxiliary code			Operation	Timer	Ready	Flash		
F13	01: Compressor 1 side 02: Compressor 2 side 03: Compressor 3 side	F13	◎	◎	○	A	Outdoor IGBT built-in temp. sensor (TH) error	Open/Short of outdoor unit IGBT built-in temp. sensor (TH) was detected.
H01	01: Compressor 1 side 02: Compressor 2 side 03: Compressor 3 side	H01	●	◎	●		Compressor break down	Inverter current (Idc) detection circuit detected over-current.
H02	01: Compressor 1 side 02: Compressor 2 side 03: Compressor 3 side	H02	●	◎	●		Compressor error (Lock)	Compressor lock was detected.
H03	01: Compressor 1 side 02: Compressor 2 side 03: Compressor 3 side	H03	●	◎	●		Current detection circuit error	Abnormal current was detected during stop of compressor.
P04	01: Compressor 1 side 02: Compressor 2 side 03: Compressor 3 side	P04	◎	●	◎	A	High pressure SW system operation	High pressure SW operated.
P07	01: Compressor 1 side 02: Compressor 2 side 03: Compressor 3 side	P07	◎	●	◎	A	Heat sink overheat error	High temp. error was detected in outdoor IGBT built-in temp. sensor (TH).
P22	0*: IGBT circuit 1*: Position detection circuit error 3*: Motor lock error 4*: Motor current detection C*: TH sensor error D*: TH sensor error E*: Inverter DC voltage error (Outdoor fan) Note) In position *, 0 to F is displayed, but ignore it.	P22	◎	●	◎	A	IPDU for outdoor fan error	IPDU for outdoor fan detected each error.
P26	01: Compressor 1 side 02: Compressor 2 side 03: Compressor 3 side	P26	◎	●	◎	A	G-Tr (IGBT) short-circuit protection error	Short-circuit protective operation (Instantaneous over-current) of compressor motor driving circuit element operated.
P29	01: Compressor 1 side 02: Compressor 2 side 03: Compressor 3 side	P29	◎	●	◎	A	Compressor position detection circuit system error	Position detection error of compressor motor was detected.

Note) The above check codes are the representative examples and they differ according to the combined outdoor units (Cooling/Heating flex, etc.).
 For details, refer to the Service Manual for the corresponding outdoor unit.

10-3. Troubleshooting by Check Display on Remote Controller

■ In case of wired remote controller (RBC-AMT32E)

1. Confirmation and check

When an error occurred on the air conditioner, the check code and the indoor unit No. are displayed on the display section of the remote controller.

The check code is displayed while the air conditioner operates.

If the display disappeared, operate the air conditioner and check the error based upon the following "Confirmation of error history".

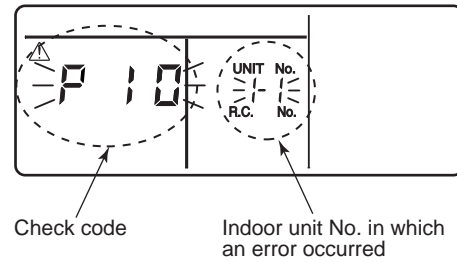

2. Confirmation of error history

When an error occurred on the air conditioner, the error history can be confirmed with the following procedure.

(Up to 4 error histories are stored in memory.)

This history can be confirmed from either operating status or stop status.

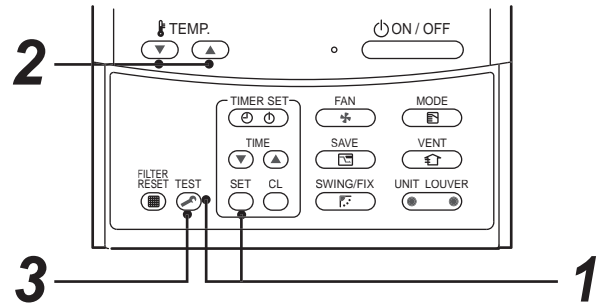

Procedure	Description
1	<p>When pushing and buttons simultaneously for 4 seconds or more, the below display appears. If [Service Check] is displayed, the mode enters in the error history mode.</p> <ul style="list-style-type: none"> • [01: Error history order] is displayed in CODE No. window. • [Check Code] is displayed in check code window. • [Indoor unit address with error] is displayed in UNIT No.
2	<p>Every pushing temp. set / buttons, the error histories stored in the memory are displayed in order. The numbers in CODE No. indicates CODE No. [01] (Latest) to [04] (Oldest).</p> <p>CAUTION Do not push button because all the error histories of the indoor unit will be deleted.</p>
3	<p>After confirmation, push button to return to the usual display.</p>

How to read the check monitor display

<7-segment display>



<How to read>

0 1 2 3 4 5 6 7 8 9 A b C d E F H J L P

■ In case of central remote controller (TCB-SC642TLE2)

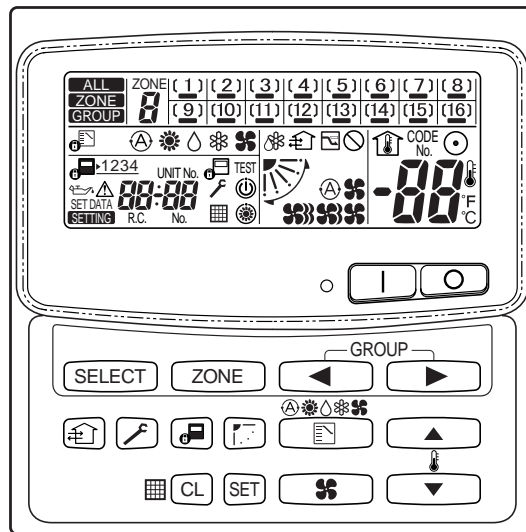

1. Confirmation and check

When a trouble occurred on the air conditioner, the check code and the indoor unit No. are displayed on the display section of the remote controller.

The check code is displayed while the air conditioner operates.

If the display disappeared, operate the air conditioner and check the error based upon the following "Confirmation of error history".

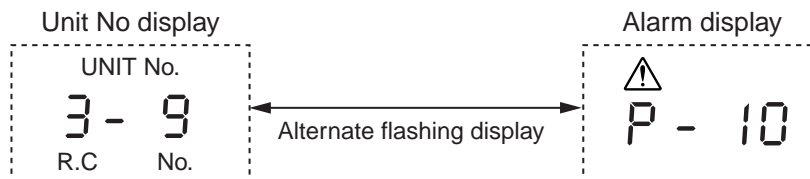

2. Confirmation of error history

When a trouble occurred on the air conditioner, the error history can be confirmed with the following procedure. (Up to 4 error histories are stored in memory.)

This history can be confirmed from either operating or stop.

- 1) Push and buttons in succession for 4 seconds or more.
- 2) SERVICE CHECK goes on and CODE No. 01 goes on.
- 3) When selecting (flash) the group number if there is the alarm history, the UNIT number and the latest alarm history are displayed alternately.
 - * In this time, the temperature cannot be set up.
- 4) To confirm the alarm history other than the latest one, push temp. set / to select CODE No. (01 to 04).
- 5) To confirm the alarm in the other group, push and / to select the group number. Do not push button because all the alarm histories of the currently selected group are deleted.
- 6) To finish the service check, push button.

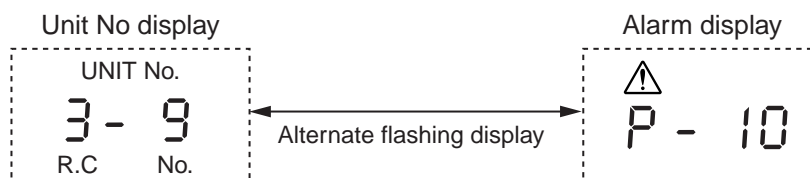





■ Indoor unit display part (Receiving unit) (Wireless type)

When specifying the check code, check 7-segment display on the center unit.

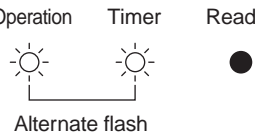
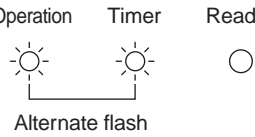
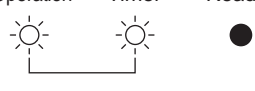

For the check code which is not displayed on the outdoor 7-segment, confirm it in Section “10-2 How to Check / Check code display list (Indoor unit)”.

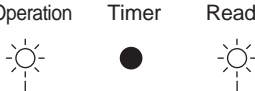
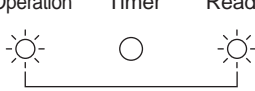
● : Goes off, ○ : Goes on, ☼ : Flash (0.5 second)

Lamp indication	Check code	Cause of trouble occurrence	
Operation Timer Ready ● ● ● No indication at all	—	Power supply OFF or miswiring between receiving unit and indoor unit	
Operation Timer Ready ☼ ● ● Flash	E01	Receiving error } Receiving unit } Miswiring or wire connection error Sending error } } between receiving unit and indoor unit Communication interruption	
	E02		
	E03		
		E08	Duplicated indoor unit No. (Address) } Duplicated header units of remote controller } Setup error
		E09	
		E10	Communication error between MCU on indoor unit P.C. board
		E12	Automatic address start error
		E18	Wire connection error between indoor units, indoor power supply OFF
Operation Timer Ready ● ● ☼ Flash		E04	Miswiring or wire connection error between indoor unit and outdoor unit (Communication interruption between indoor and outdoor units)
	E06	Communication (receiving) error between indoor and outdoor units, decrease of No. of connected indoor units	
	E07	Communication (sending) error between indoor and outdoor units	
	E15	No indoor unit during setting of automatic address	
	E16	No. of connected indoor units, capacity over	
	E19	Error of No. of header unit	
	E20	Disagreement of refrigerant pipe communication during setting of automatic address	
	E23	Communication (sending) error between outdoor units	
	E25	Duplicated setting of follower unit address	
	E26	Communication (receiving) error between outdoor units, decrease of No. of connected outdoor units	
	E28	Follower unit error	
	E31	IPDU communication error	
	Operation Timer Ready ● ☼ ☼ Alternate flash	P01	Indoor fan error
P10		Indoor overflow error	
P12		Indoor fan error	
P13		Outdoor unit liquid back detection error	
Operation Timer Ready ☼ ● ☼ Alternate flash	P03	Outdoor unit discharge temp. (TD1) error	
	P04	Outdoor unit high pressure switch operation	
	P05	Outdoor unit inverter DC voltage (Vdc) error was detected, negative phase error was detected	
	P07	Outdoor unit heat sink overheat error: Heat radiation error of electric part (IGBT) in outdoor unit	
	P15	Gas leak was detected: Short of refrigerant charge amount	
	P17	Outdoor unit discharge temp. (TD2) error	
	P18	Outdoor unit discharge temp. (TD3) error	
	P19	Outdoor unit 4-way valve inverse error	
	P20	High pressure protection error	
	P22	Outdoor unit DC fan error	
	P26	Outdoor unit G-Tr short-circuit error	
	P29	Compressor position detection circuit error	
	P31	Other indoor unit stopped due to error in the group.	

Lamp indication	Check code	Cause of trouble occurrence
Operation Timer Ready  Alternate flash	F01	Heat exchanger sensor (TCJ) error Heat exchanger sensor (TC2) error Heat exchanger sensor (TC1) error Room temp. sensor (TA) error Discharge air temp. sensor (TF) error } Temp. sensor error in indoor unit
	F02	
	F03	
	F10	
	F11	
Operation Timer Ready  Alternate flash	F04	Discharge temp. sensor (TD1) error Discharge temp. sensor (TD2) error Heat exchanger sensor (TE1, TE2) error Liquid temp. sensor (TL) error Outside temp. sensor (TO) error Suction temp. sensor (TS1) error Heat sink sensor (TH) error } Outdoor unit temp. sensor error
	F05	
	F06	
	F07	
	F08	
	F12	
	F13	
	F15	Misconnection of heat exchanger sensor (TE) with liquid temp. sensor (TL) → Miswiring of temp. sensor in outdoor unit or miss-mounting Miswiring between high pressure sensor (Pd) and low pressure sensor (Ps) → Misconnection of pressure sensor in outdoor unit
	F16	
	F22	
	F23	Discharge temp. sensor (TD3) error Low pressure sensor (Ps) error High pressure sensor (Pd) error } Pressure sensor error in outdoor unit
	F24	
	Operation Timer Ready  Simultaneous flash	F29
Operation Timer Ready  Flash		H01
	H02	
	H03	
	H04	Compressor 1 case thermo operation
	H05	Miswiring or mismounting of outdoor discharge temp. sensor (TD1) or coming-off of TD1 sensor
	H06	Low pressure (Ps) drop error Oil face drop detection error } Protections stop of outdoor unit
	H07	
	H08	Oil face detection circuit system temp. sensor (TK1, TK2, TK3, TK4, TK5) error
	H15	Miswiring or mismounting of outdoor discharge temp. sensor (TD2) or coming-off of TD2 sensor
	H16	Oil face detection circuit system error: Outdoor unit TK1, TK2, TK3, TK4 circuit system error
H25	Miswiring or mismounting of outdoor discharge temp. sensor (TD3) or coming-off of TD3 sensor	
Operation Timer Ready  Simultaneous flash	L03	Duplicated header units in indoor unit
	L05	Duplicated priority indoor unit (Displayed in the room with priority)
	L06	Duplicated priority indoor unit (Displayed in a room except one with priority)
	L07	Group cable was connected to individual indoor unit.
	L08	Indoor group address was unset.
	L09	Indoor capacity was unset.
Operation Timer Ready  Simultaneous flash	L04	Duplicated setting of outdoor line address
	L10	Outdoor capacity was unset.
	L17	Disagreement error of outdoor unit type
	L18	Flow selector unit error
	L20	Duplicated address of central control system
	L28	No. of connected outdoor units over
	L29	Defective No. of IPDU
L30	Indoor unit outside interlock error	
Operation Timer Ready  Simultaneous flash	F31	Outdoor unit EEPROM error

■ Others (Except check code)

Lamp indication	Check code	Cause of trouble occurrence
Operation Timer Ready  Simultaneous flash	—	During test run
Operation Timer Ready  Alternate flash	—	COOL/HEAT disagreement (Automatic cooling/heating setup to automatic cooling/heating unavailable model, heating setup to cooling only model)

10-4. Check Code and Check Position Displayed on the Remote Controller and Outdoor Unit (7-Segment Display of Interface)

<In case of SUPER MODULAR MULTI SYSTEM>

Wired remote controller	Check code		Detected position	Check code name	Status	Error detection condition	Check item (position)
	Outdoor 7-segment display						
	Check code	Auxiliary code					
E01	—	—	Remote controller	Communication error between indoor and remote controller (Detected at remote controller side)	Corresponding unit only stops.	Communication interrupted between indoor P.C. board and remote controller.	<ul style="list-style-type: none"> • Check remote controller inter-unit cable (A/B). • Check disconnection, connector contact error. • Check indoor power supply. • Check indoor P.C. board error. • Check remote controller address setup. (When two remote controllers operate) • Check remote controller P.C. board.
E02	—	—	Remote controller	Remote controller sending error	Corresponding unit only stops.	Signal could not be sent from remote controller to indoor unit.	<ul style="list-style-type: none"> • Check the communication wire of remote controller: Exchange remote controller.
E03	—	—	Indoor unit	Communication error between indoor and remote controller (Detected at indoor side)	Corresponding unit only stops.	No communication from remote controller (including wireless) and communication adapter.	<ul style="list-style-type: none"> • Check remote controller and communication adapter wiring.
E04	—	—	Indoor unit	Indoor/outdoor communication circuit error (Detected at indoor side)	Corresponding unit only stops.	Indoor unit does not receive communication from outdoor unit.	<ul style="list-style-type: none"> • Check power-ON order of indoor/outdoor. • Check indoor address setup. • Check inter-unit cabling between indoor and outdoor. • Check outdoor end terminal resistance setup (SW30-2).
E06	E06	No. of indoor units which received signal normally	I/F	Decreased number of indoor units	All stop	When signal is not sent for a certain period from the indoor unit which has been used to send signals.	<ul style="list-style-type: none"> • Check the power supply of indoor unit. (Power-ON) • Check connection of communication line between indoor and outdoor. • Check connector connection for communication in indoor P.C. board. • Check connector connection for communication in outdoor P.C. board. • Check indoor P.C. board failure. • Check outdoor P.C. board (I/F) failure.
—	E07	—	I/F	Indoor/outdoor communication circuit error (Detected at outdoor side)	All stop	Transmission from outdoor to indoor cannot continue for 30 seconds.	<ul style="list-style-type: none"> • Check outdoor terminator resistor setup (SW30-2). • Check the communication connection between indoor and outdoor.
E08	E08	Duplicated indoor addresses	Indoor I/F	Duplicated indoor addresses	All stop	Multiple indoor unit address setup are duplicated.	<ul style="list-style-type: none"> • Check indoor address. • Check the change of remote controller connection (Group / individual) after setup of indoor address.
E09	—	—	Remote controller	Duplicated master remote controllers	Corresponding unit only stops.	In 2-remote controller control (including wireless), both are setup as master (Header indoor unit stops and other indoor unit is operating.)	<ul style="list-style-type: none"> • Check remote controller setup. • Check remote controller P.C. board.
E10	—	—	Indoor unit	Communication error between indoor P.C. board assembly	Corresponding unit only stops.	Communication was not succeeded after power was supplied or during communication.	<ul style="list-style-type: none"> • Indoor P.C. board failure
E12	E12	01: Indoor/outdoor communication 02: Between outdoors communication	I/F	Automatic address start error	All stop	<ul style="list-style-type: none"> • When indoor automatic address started, other refrigerant circuit system was setting automatic address. • When outdoor automatic address started, indoor automatic address was executed. 	<ul style="list-style-type: none"> • Setup the address again after disconnecting communication connection with other refrigerant circuit system.

Wired remote controller	Check code		Detected position	Check code name	Status	Error detection condition	Check item (position)
	Outdoor 7-segment display						
	Check code	Auxiliary code					
E15	E15	—	I/F	No corresponding indoor unit during automatic address	All stop	Indoor unit is not found when indoor automatic address start was set up.	<ul style="list-style-type: none"> • Check the communication line connection between indoor and outdoor. • Check the electric power line error in indoor. • Check the noise of surrounding devices. • Power failure • Check indoor P.C. board error.
E16	E16	00: Capacity over 01 to: No. of connected units	I/F	No. of connected indoor units / Capacity over	All stop	<ul style="list-style-type: none"> • Total capacity of indoor units exceeded 135% of total outdoor capacity. • No. of connected indoor units are more than 48 units. <p>[Note] If this code appears after backup setup of outdoor unit trouble, set up "No. capacity-over detection".</p> <p><Setup method of "No. capacity-over detection"> Turn on SW09/Bit 2 on I/F P.C. board of outdoor header unit.</p>	<ul style="list-style-type: none"> • Check the connection capacity of indoor unit. • Check the HP capacity of indoor unit. • Check the indoor/outdoor capacity setup • Check the No. of connected indoor units. • Check the outdoor I/F P.C. board error
E18	—	—	Indoor unit	Communication error between indoor header and follower units	Corresponding unit only stops.	Regular communication between indoor header and follower units	<ul style="list-style-type: none"> • Check cable of the remote controller. • Check power cabling of indoor. • Check P.C. board of indoor.
E19	E19	00: No header unit 02: Two or more header units	I/F	Header outdoor unit quantity error	All stop	<ul style="list-style-type: none"> • There are multiple header outdoor units in 1 line. • There is none of header outdoor unit in 1 line. 	<p>The outdoor unit connected with communication cable between indoor and outdoor (U1.U2) is the outdoor unit.</p> <ul style="list-style-type: none"> • Check connection of communication line between indoor and outdoor. • Check outdoor P.C. board(I/F) error.
E20	E20	01: Connection of outdoor of other line 02: Connection of indoor of other line	I/F	Other line unit connected during automatic address	All stop	Unit of other line was connected when indoor automatic address started.	Separate the cable between lines according to automatic address setup method in "Address setup".
E23	E23	—	I/F	Communication sending error between outdoor units	All stop	Transmission of other outdoor unit was unavailable for 30 seconds or more.	<ul style="list-style-type: none"> • Check power supply in outdoor unit. (Is power supplied?) • Check connection or disconnection of connecting wire between outdoor units. • Check connection of connector for outdoor P.C. board communication. • Check outdoor P.C. board (I/F) error. • Check terminal resistance setting of communication between outdoor units
E25	E25	—	I/F	Duplicated outdoor follower address setup	All stop	Outdoor addresses manually set up are duplicated.	[Note] Do not set up the outdoor address manually.
E26	E26	No. of normally received outdoor units	I/F	Decreased number of connected outdoor units	All stop	The signal was not returned for constant from the outdoor unit which was receiving signal.	<ul style="list-style-type: none"> • Outdoor backup is being set. • Check power supply of outdoor unit. (Is power supplied?) • Check connection or disconnection of connecting wire between outdoor units. • Check connection of connector for outdoor P.C. board communication. • Check outdoor P.C. board (I/F) error.
E28	E28	No. of detected outdoor units	I/F	Outdoor follower unit error	All stop	Outdoor header unit received error code from outdoor follower unit.	<ul style="list-style-type: none"> • Check the check code of outdoor follower unit.
<Convenient functions>							
<p>When pushing SW04 for 1 second or more under condition that [E28] is displayed on 7-segment display of outdoor header unit, the fan of outdoor unit which stopped abnormally starts rotating. If pushing SW04 and SW05 simultaneously, the fan of normal outdoor unit operates. When pushing SW05 singly, the operation of fan is cleared.</p>							

Check code		Detected position	Check code name	Status	Error detection condition	Check item (position)																																																																																																											
Wired remote controller	Outdoor 7-segment display																																																																																																																
	Check code						Auxiliary code																																																																																																										
E31	E31	<table border="1"> <thead> <tr> <th rowspan="2"></th> <th colspan="3">A-3-IPDU</th> <th rowspan="2">FAN IPDU</th> <th rowspan="2"></th> <th colspan="3">A-3-IPDU</th> <th rowspan="2">FAN IPDU</th> </tr> <tr> <th>1</th> <th>2</th> <th>3</th> <th>1</th> <th>2</th> <th>3</th> </tr> </thead> <tbody> <tr> <td>01</td> <td>○</td> <td></td> <td></td> <td></td> <td>0A</td> <td></td> <td>○</td> <td></td> <td>○</td> </tr> <tr> <td>02</td> <td></td> <td>○</td> <td></td> <td></td> <td>0B</td> <td>○</td> <td>○</td> <td></td> <td>○</td> </tr> <tr> <td>03</td> <td>○</td> <td>○</td> <td></td> <td></td> <td>0C</td> <td></td> <td></td> <td>○</td> <td>○</td> </tr> <tr> <td>04</td> <td></td> <td></td> <td>○</td> <td></td> <td>0D</td> <td>○</td> <td></td> <td>○</td> <td>○</td> </tr> <tr> <td>05</td> <td>○</td> <td></td> <td>○</td> <td></td> <td>0E</td> <td></td> <td>○</td> <td>○</td> <td>○</td> </tr> <tr> <td>06</td> <td></td> <td>○</td> <td>○</td> <td></td> <td>0F</td> <td>○</td> <td>○</td> <td>○</td> <td>○</td> </tr> <tr> <td>07</td> <td>○</td> <td>○</td> <td>○</td> <td></td> <td></td> <td></td> <td></td> <td></td> <td></td> </tr> <tr> <td>08</td> <td></td> <td></td> <td></td> <td>○</td> <td></td> <td></td> <td></td> <td></td> <td></td> </tr> <tr> <td>09</td> <td>○</td> <td></td> <td></td> <td>○</td> <td></td> <td></td> <td></td> <td></td> <td></td> </tr> </tbody> </table> <p>○ mark: Error position.</p>		A-3-IPDU			FAN IPDU		A-3-IPDU			FAN IPDU	1	2	3	1	2	3	01	○				0A		○		○	02		○			0B	○	○		○	03	○	○			0C			○	○	04			○		0D	○		○	○	05	○		○		0E		○	○	○	06		○	○		0F	○	○	○	○	07	○	○	○							08				○						09	○			○						I/F	IPDU communication error	All stop	Communication of each IPDU (P.C. board) in inverter box interrupted.	<ul style="list-style-type: none"> • Check connection of communication connector and disconnection between IPDU and I/F P.C. board. • Check outdoor P.C. board (I/F, Comp., IPDU, Fan IPDU) error. • Check external noise.
	A-3-IPDU			FAN IPDU		A-3-IPDU			FAN IPDU																																																																																																								
	1	2	3			1	2	3																																																																																																									
01	○				0A		○		○																																																																																																								
02		○			0B	○	○		○																																																																																																								
03	○	○			0C			○	○																																																																																																								
04			○		0D	○		○	○																																																																																																								
05	○		○		0E		○	○	○																																																																																																								
06		○	○		0F	○	○	○	○																																																																																																								
07	○	○	○																																																																																																														
08				○																																																																																																													
09	○			○																																																																																																													
F01	—	—	Indoor unit	Indoor TCJ sensor error	Corresponding unit only stops.	<ul style="list-style-type: none"> • Resistance value of sensor is infinite or zero. (Open/Short) 	<ul style="list-style-type: none"> • Check connection/cabling of TCJ sensor connector. • Check characteristics of TCJ sensor resistance value. • Check indoor P.C. board error. 																																																																																																										
F02	—	—	Indoor unit	Indoor TC2 sensor error	Corresponding unit only stops.	<ul style="list-style-type: none"> • Resistance value of sensor is infinite or zero (Open/Short). 	<ul style="list-style-type: none"> • Check connection/cabling of TC2 sensor connector. • Check characteristics of TC2 sensor resistance value. • Check indoor P.C. board error. 																																																																																																										
F03	—	—	Indoor unit	Indoor TC1 sensor error	Corresponding unit only stops.	<ul style="list-style-type: none"> • Resistance value of sensor is infinite or zero (Open/Short). 	<ul style="list-style-type: none"> • Check connection/cabling of TC1 sensor connector. • Check characteristics of TC1 sensor resistance value. • Check indoor P.C. board error. 																																																																																																										
F04	F04	—	I/F	TD1 sensor error	All stop	<ul style="list-style-type: none"> • Resistance value of sensor is infinite or zero (Open/Short) 	<ul style="list-style-type: none"> • Check connection of TD1 sensor connector. • Check characteristics of TD1 sensor resistance value. • Check outdoor P.C. board (I/F) error. 																																																																																																										
F05	F05	—	I/F	TD2 sensor error	All stop	<ul style="list-style-type: none"> • Resistance value of sensor is infinite or zero (Open/Short) 	<ul style="list-style-type: none"> • Check connection of TD2 sensor connector. • Check characteristics of TD2 sensor resistance value. • Check outdoor P.C. board (I/F) error. 																																																																																																										
F06	F06	01: TE1 sensor error 02: TE2 sensor error	I/F	TE1, TE2 sensor error	All stop	<ul style="list-style-type: none"> • Resistance value of sensor is infinite or zero (Open/Short). 	<ul style="list-style-type: none"> • Check connection of TE1, TE2 sensor connector. • Check characteristics of TE1, TE2 sensor resistance value. • Check outdoor P.C. board (I/F) error. 																																																																																																										
F07	F07	—	I/F	TL sensor error	All stop	<ul style="list-style-type: none"> • Resistance value of sensor is infinite or zero (Open/Short). 	<ul style="list-style-type: none"> • Check connection of TL sensor connector. • Check characteristics of TL sensor resistance value. • Check outdoor P.C. board (I/F) error. 																																																																																																										
F08	F08	—	I/F	TO sensor error	All stop	<ul style="list-style-type: none"> • Resistance value of sensor is infinite or zero (Open/Short). 	<ul style="list-style-type: none"> • Check connection of TO sensor connector. • Check characteristics of TO sensor resistance value. • Check outdoor P.C. board (I/F) error. 																																																																																																										
F10	—	—	Indoor	Indoor TA sensor error	Corresponding unit only stops.	<ul style="list-style-type: none"> • Resistance value of sensor is infinite or zero (Open/Short). 	<ul style="list-style-type: none"> • Check connection/cabling of TA sensor connector. • Check characteristics of TA sensor resistance value. • Check indoor P.C. board error. 																																																																																																										
F12	F12	—	I/F	TS1 sensor error	All stop	<ul style="list-style-type: none"> • Resistance value of sensor is infinite or zero (Open/Short). 	<ul style="list-style-type: none"> • Check connection of TS1 sensor connector. • Check characteristics of TS1 sensor resistance value. • Check outdoor P.C. board (I/F) error. 																																																																																																										
F13	F13	01: Compressor 1 side 02: Compressor 2 side 03: Compressor 3 side	IPDU	TH sensor error	All stop	<ul style="list-style-type: none"> • Resistance value of sensor is infinite or zero (Open/Short). 	<ul style="list-style-type: none"> • IGBT built-in temp sensor error → Exchange Comp. IPDU P.C. board. 																																																																																																										

Wired remote controller	Check code		Detected position	Check code name	Status	Error detection condition	Check item (position)
	Outdoor 7-segment display						
	Check code	Auxiliary code					
F15	F15	—	I/F	Outdoor temp sensor miscabling (TE1, TL)	All stop	During operation of compressor in HEAT mode, the TE1 detection temp was higher than that of TL by the specified value continued for 3 minutes or more.	<ul style="list-style-type: none"> • Check installation of TE1 sensor and TL sensor. • Check characteristics of TE1 and TL sensor resistance value. • Check outdoor P.C. board (I/F) error.
F16	F16	—	I/F	Outdoor pressure sensor miscabling (Pd, Ps)	All stop	High-pressure Pd sensor and low-pressure Ps sensor were exchanged, or output voltages of both sensors are zero.	<ul style="list-style-type: none"> • Check connection of high-pressure Pd sensor connector. • Check connection of low-pressure Ps sensor connector. • Check pressure sensors Pd and Ps error. • Check outdoor P.C. board (I/F) error. • Check compression error of compressor.
F22	F22	—	I/F	TD3 sensor error	All stop	Sensor resistance value is infinite or 0 (Open/Short)	<ul style="list-style-type: none"> • Check connection of TD3 sensor connector. • Check resistance value characteristics of TD3. • Check error of outdoor P.C. board (I/F).
F23	F23	—	I/F	Ps sensor error	All stop	Output voltage of Ps sensor was zero.	<ul style="list-style-type: none"> • Misconnection of Ps sensor and Pd sensor connectors • Check connection of Ps sensor connector. • Check Ps sensor error. • Check compression error of compressor. • Check 4-way valve error. • Check outdoor P.C. board (I/F) error. • Check SV4 circuit error.
F24	F24	—	I/F	Pd sensor error	All stop	Output voltage of Pd sensor was zero. (Sensor Open) Pd > 4.15MPa during stop of compressor	<ul style="list-style-type: none"> • Check connection of Pd sensor connector. • Check Pd sensor error. • Check outdoor P.C. board (I/F) error.
F29	—	—	Indoor	Indoor other error	Corresponding unit only stops.	Indoor P.C. board did not operate normally.	<ul style="list-style-type: none"> • Check indoor P.C. board error (EEPROM error).
F31	F31	—	I/F	Outdoor EEPROM error	All stop (*1)	Outdoor P.C. board (I/F) did not operate normally.	<ul style="list-style-type: none"> • Check power voltage. • Check power noise. • Check outdoor P.C. board (I/F) error.
H01	H01	01: Compressor 1 side 02: Compressor 2 side 03: Compressor 3 side	IPDU	Compressor breakdown	All stop	Inverter current detection circuit detected over-current and stopped.	<ul style="list-style-type: none"> • Check power voltage. (AC380–415V ± 10%). • Check compressor error. • Check cause of abnormal overload operation. • Check outdoor P.C. board (Comp. IPDU) error.
H02	H02	01: Compressor 1 side 02: Compressor 2 side 03: Compressor 3 side	IPDU	Compressor error (lock)	All stop	Over-current was detected several seconds after header compressor had started.	<ul style="list-style-type: none"> • Check compressor error. • Check power voltage. (AC380–415V ±10%). • Check cable of compressor and phase-missing. • Check connector/terminal connection on IPDU P.C. board. • Check conduction of case heater. (Check activation error due to liquid stagnation in compressor.) • Check outdoor P.C. board (Comp. IPDU) error.
H03	H03	01: Compressor 1 side 02: Compressor 2 side 03: Compressor 3 side	IPDU	Current detection circuit system error	All stop	While header compressor stopped, current flowed more than the specified current and was detected.	<ul style="list-style-type: none"> • Check cabling of current detection circuit system. • Check outdoor P.C. board (Comp. IPDU) error.

(*1) All stop only in case of the header unit. The follower unit continues operation.

Wired remote controller	Check code		Detected position	Check code name	Status	Error detection condition	Check item (position)
	Outdoor 7-segment display						
	Check code	Auxiliary code					
H04	H04	—	I/F	Compressor 1 case thermo operation	All stop	Compressor 1 case thermostat performed protective operation.	<ul style="list-style-type: none"> • Check compressor 1 case thermo circuit. (Connector, cable, P.C. board) • Check full opening of service valve. (Gas and liquid side) • Check outdoor PMV clogging. (PMV1, 2) • Check SV41 circuit leakage. • Check miscabling/misinstallation of SV41 and SV42. • Check valve open status of indoor PMV. • Check 4-way valve error. • Check refrigerant shortage.
H05	H05	—	I/F	Outdoor unit discharge temp. sensor (TD1) miswiring	All stop	While compressor 1 is operating, the discharge temp. (TD1) does not rise up.	<ul style="list-style-type: none"> • Check mounting of TD1 sensor. • Check connection and wiring of TD1 sensor connector. • Check characteristics of TD1 sensor resistance value. • Check outdoor unit P.C. board (I/F) error.
H06	H06	—	I/F	Low-pressure protective operation	All stop	Low-pressure Ps detected operation lower than 0.02MPa.	<ul style="list-style-type: none"> • Check full opening of service valve. (Discharge gas, suction gas and liquid side) • Check outdoor PMV clogging. (PMV1, 2) • Check SV2 circuit and SV4 circuit error. • Check low-pressure Ps sensor error. • Check indoor air filter clogging. • Check valve open of indoor PMV. • Check refrigerant pipe clogging. • Check outdoor fan operation. (All heating, mainly heating, part cooling operation) • Check refrigerant shortage.
H07	H07	—	I/F	Protection for oil level drop detection	All stop	The operating compressor detected oil shortage continuously for 2 hours.	<p><Check all the outdoor units in the corresponding line.></p> <ul style="list-style-type: none"> • Check full opening of service valve of balance pipe. • Check connection and installation of TK1, TK2, TK3, and TK4 sensors. • Check characteristics of TK1, TK2, TK3, and TK4 resistance values. • Check gas leak and oil leak in the same line. • Check refrigerant stagnation in compressor. • Check error of SV3A, SV3B, SV3C, SV3D, and SV3E valves. • Check clogging of oil separator oil return circuit. • Check clogging of oil-equation circuit.
H08	H08	01: TK1 sensor error 02: TK2 sensor error 03: TK3 sensor error 04: TK4 sensor error 05: TK5 sensor error	I/F	Oil level detective temp sensor error	All stop	• Resistance value of sensor is infinite or zero. (Open/Short)	<ul style="list-style-type: none"> • Check connection of TK1 sensor connector. • Check characteristics of TK1 sensor resistance value. • Check outdoor P.C. board (I/F) error.
					All stop	• Resistance value of sensor is infinite or zero. (Open/Short)	<ul style="list-style-type: none"> • Check connection of TK2 sensor connector. • Check characteristics of TK2 sensor resistance value. • Check outdoor P.C. board (I/F) error.
					All stop	• Resistance value of sensor is infinite or zero. (Open/Short)	<ul style="list-style-type: none"> • Check connection of TK3 sensor connector. • Check characteristics of TK3 sensor resistance value. • Check outdoor P.C. board (I/F) error.
					All stop	• Resistance value of sensor is infinite or zero. (Open/Short)	<ul style="list-style-type: none"> • Check connection of TK4 sensor connector. • Check characteristics of TK4 sensor resistance value. • Check outdoor P.C. board (I/F) error.
					All stop	• Resistance value of sensor is infinite or zero. (Open/Short)	<ul style="list-style-type: none"> • Check connection of TK5 sensor connector. • Check characteristics of TK5 sensor resistance value. • Check outdoor P.C. board (I/F) error.

Wired remote controller	Check code		Detected position	Check code name	Status	Error detection condition	Check item (position)
	Outdoor 7-segment display						
	Check code	Auxiliary code					
H15	H15	—	I/F	Outdoor unit discharge temp. sensor (TD2) miswiring	All stop	While compressor 2 is operating, the discharge temp. (TD2) does not rise up.	<ul style="list-style-type: none"> • Check mounting of TD2 sensor. • Check connection and wiring of TD2 sensor connector. • Check characteristics of TD2 sensor resistance value. • Check outdoor unit P.C. board (I/F) error.
H16	H16	01: TK1 oil circuit system error 02: TK2 oil circuit system error 03: TK3 oil circuit system error 04: TK4 oil circuit system error 05: TK5 oil circuit system error	I/F	Oil level detective circuit system error	All stop	Temperature change of TK1 could not be detected though compressor 1 started the operation.	<ul style="list-style-type: none"> • Check TK1 sensor coming-off. • Check characteristics of TK1 sensor resistance value. • Check TK1, TK2, TK3, TK4 and TK5 misconnection. • Check operation error of SV3E, SV3F valve. • Check capillary clogging of oil-equalization circuit and operation error of stop valve. • Check refrigerant stagnation in compressor.
						Temperature change of TK2 could not be detected though compressor 2 started the operation.	<ul style="list-style-type: none"> • Check TK2 sensor coming-off. • Check characteristics of TK2 sensor resistance value. • Check TK1, TK2, TK3, TK4 and TK5 misconnection. • Check SV3E, SV3F valve operation. • Check capillary clogging of oil equalization circuit and check stop valve operation. • Check refrigerant stagnation in compressor shell.
						Temperature change of TK3 could not be detected though compressor started the operation.	<ul style="list-style-type: none"> • Check TK3 sensor coming-off. • Check characteristics of TK3 sensor resistance value. • Check TK1, TK2, TK3, TK4 and TK5 misconnection. • Check SV3E, SV3F valve operation. • Check capillary clogging of oil-equalization circuit and check valve operation. • Check refrigerant stagnation in compressor shell.
						Temperature change of TK4 could not be detected though compressor started the operation, or the difference from other TK sensor changed for a constant time only within the specified range.	<ul style="list-style-type: none"> • Check TK4 sensor coming-off. • Check characteristics of TK4 sensor resistance value. • Check TK1, TK2, TK3, TK4 and TK5 misconnection. • Check SV3E, SV3F valve operation. • Check capillary clogging of oil-equalization circuit and check valve operation. • Check refrigerant stagnation in compressor shell.
						Temperature change of TK5 could not be detected though compressor started the operation, or the difference from other TK sensor changed for a constant time only within the specified range.	<ul style="list-style-type: none"> • Check TK5 sensor coming-off. • Check characteristics of TK5 sensor resistance value. • Check TK1, TK2, TK3, TK4 and TK5 misconnection. • Check SV3E valve operation error. • Check capillary clogging of oil-equalization circuit and check valve operation error. • Check refrigerant stagnation in compressor.
H25	H25	—	I/F	Outdoor unit discharge temp. sensor (TD3) miswiring	All stop	While compressor 2 is operating, the discharge temp. (TD3) does not rise up.	<ul style="list-style-type: none"> • Check mounting of TD3 sensor. • Check connection and wiring of TD3 sensor connector. • Check characteristics of TD3 sensor resistance value. • Check outdoor unit P.C. board (I/F) error.
L03	—	—	Indoor	Duplicated indoor center units	Corresponding unit only stops.	There are multiple center units in a group.	<ul style="list-style-type: none"> • Check indoor address. • Check the change of remote controller connection (Group/individual) after indoor address setup.
L04	L04	—	I/F	Duplicated outdoor line address	All stop	Line address setup is duplicated against the outdoor unit in different refrigerant pipe system.	<ul style="list-style-type: none"> • Check line address.

Wired remote controller	Check code		Detected position	Check code name	Status	Error detection condition	Check item (position)																																																																																																										
	Outdoor 7-segment display																																																																																																																
	Check code	Auxiliary code																																																																																																															
L05	—	—	I/F	Duplicated indoor units with priority (Displayed on indoor unit with priority)	All stop	Indoor units with priority were duplicated.	• Check display of indoor unit with priority.																																																																																																										
L06	L06	No. of indoor units with priority	I/F	Duplicated indoor units with priority (Displayed on the unit other than indoor unit with priority)	All stop	Indoor units with priority were duplicated.	• Check display of indoor unit with priority and outdoor unit.																																																																																																										
L07	—	—	Indoor	Group line in individual indoor unit.	Corresponding unit only stops.	At least one indoor unit connected to a group existed in the individual indoor units.	• Check indoor address.																																																																																																										
L08	L08	—	Indoor	Indoor group / address unset	Corresponding unit only stops.	Address was not yet set up.	• Check indoor address. Note) After installation, this code is displayed when the power is firstly turned on.																																																																																																										
L09	—	—	Indoor	Indoor capacity unset	Corresponding unit only stops.	Indoor unit capacity was unset.	Set up indoor capacity. (DN=11)																																																																																																										
L10	L10	—	I/F	Outdoor capacity unset	All stop	On the I/F P.C. board for service, jumper line was not cut according to the model.	Check model setup on outdoor I/F P.C. board A'ssy for service.																																																																																																										
L20	—	—	TCC-Link Indoor	Duplicated central control addresses	All stop	Duplicated central control addresses	• Check central control address. • Check network adaptor P.C. board. (In case of TCC-Link)																																																																																																										
L28	L28	—	I/F	Quantity over of connected outdoor units	All stop	There were more than four outdoor units.	• Check No. of connected outdoor units. (Max. 4 units per 1 system) • Check communication line between outdoor units. • Check outdoor P.C. board (I/F) error.																																																																																																										
L29	L29	<table border="1"> <thead> <tr> <th rowspan="2"></th> <th colspan="3">A-3-IPDU</th> <th rowspan="2">FAN IPDU</th> <th rowspan="2"></th> <th colspan="3">A-3-IPDU</th> <th rowspan="2">FAN IPDU</th> </tr> <tr> <th>1</th> <th>2</th> <th>3</th> <th>1</th> <th>2</th> <th>3</th> </tr> </thead> <tbody> <tr> <td>01</td> <td>○</td> <td></td> <td></td> <td></td> <td>0A</td> <td>○</td> <td></td> <td></td> <td>○</td> </tr> <tr> <td>02</td> <td></td> <td>○</td> <td></td> <td></td> <td>0B</td> <td>○</td> <td>○</td> <td></td> <td>○</td> </tr> <tr> <td>03</td> <td>○</td> <td>○</td> <td></td> <td></td> <td>0C</td> <td></td> <td></td> <td>○</td> <td>○</td> </tr> <tr> <td>04</td> <td></td> <td></td> <td>○</td> <td></td> <td>0D</td> <td>○</td> <td></td> <td>○</td> <td>○</td> </tr> <tr> <td>05</td> <td>○</td> <td></td> <td>○</td> <td></td> <td>0E</td> <td></td> <td>○</td> <td>○</td> <td>○</td> </tr> <tr> <td>06</td> <td></td> <td>○</td> <td>○</td> <td></td> <td>0F</td> <td>○</td> <td>○</td> <td>○</td> <td>○</td> </tr> <tr> <td>07</td> <td>○</td> <td>○</td> <td>○</td> <td></td> <td></td> <td></td> <td></td> <td></td> <td></td> </tr> <tr> <td>08</td> <td></td> <td></td> <td></td> <td>○</td> <td></td> <td></td> <td></td> <td></td> <td></td> </tr> <tr> <td>09</td> <td>○</td> <td></td> <td></td> <td>○</td> <td></td> <td></td> <td></td> <td></td> <td></td> </tr> </tbody> </table> <p>○ mark: Error position.</p>		A-3-IPDU			FAN IPDU		A-3-IPDU			FAN IPDU	1	2	3	1	2	3	01	○				0A	○			○	02		○			0B	○	○		○	03	○	○			0C			○	○	04			○		0D	○		○	○	05	○		○		0E		○	○	○	06		○	○		0F	○	○	○	○	07	○	○	○							08				○						09	○			○						I/F	IPDU quantity error	All stop	No. of IPDU units detected when power was turned on were less.	• Check model setup for outdoor I/F service P.C. board. • Check connection of UART communication connector. • Check Comp. IPDU, fan IPDU, and I/F P.C. board error. Note) UART: Universal Asynchronous Receiver Transmitter
	A-3-IPDU			FAN IPDU		A-3-IPDU			FAN IPDU																																																																																																								
	1	2	3			1	2	3																																																																																																									
01	○				0A	○			○																																																																																																								
02		○			0B	○	○		○																																																																																																								
03	○	○			0C			○	○																																																																																																								
04			○		0D	○		○	○																																																																																																								
05	○		○		0E		○	○	○																																																																																																								
06		○	○		0F	○	○	○	○																																																																																																								
07	○	○	○																																																																																																														
08				○																																																																																																													
09	○			○																																																																																																													
L30	L30	Detected indoor address	Indoor	Interlock in indoor unit from outside	Corresponding unit only stops.	• Outside error input terminal Detected signal to (CN80) for more 1 minute	<ul style="list-style-type: none"> ■ Outside device is connected to connector (CN80): 1) Check outside device error. 2) Check indoor P.C. board error. ■ Outside device is not connected to connector (CN80): 1) Check indoor P.C. board error. 																																																																																																										
—	L31	—	I/F	Extended IC (Integrated Circuit) error	Operation continues.	P.C. board (I/F) parts error	Check indoor (I/F) P.C. board.																																																																																																										

Wired remote controller	Check code		Detected position	Check code name	Status	Error detection condition	Check item (position)
	Outdoor 7-segment display						
	Check code	Auxiliary code					
P01	—	—	Indoor	Indoor fan motor error	Corresponding unit only stops.		<ul style="list-style-type: none"> • Check the lock of fan motor (AC fan). • Check cabling.
P03	P03	—	I/F	Discharge temp TD1 error	All stop	Discharge temp (TD1) exceeded 115°C.	<ul style="list-style-type: none"> • Check full opening of outdoor service valves (Gas side, Liquid side). • Check clogging of outdoor PMV. (PMV1,2, 4) • Check characteristics of TD1 sensor resistance value. • Check refrigerant shortage. • Check 4-way valve error. • Check leakage of SV4 circuit. • Check SV4 circuit. (Miswiring and misinstallation of SV41, SV42 and SV43)
P04	P04	01: Compressor 1 side 02: Compressor 2 side 03: Compressor 3 side	I/F	Actuation of high-pressure SW	All stop	High-pressure SW actuated.	<ul style="list-style-type: none"> • Check connection of high-pressure SW connector. • Check Pd pressure sensor error. • Check full opening of outdoor service valves (Gas side, Liquid side). • Check outdoor fan error. • Check outdoor fan motor error. • Check clogging of outdoor PMV. (PMV1,2) • Check clogging of indoor/outdoor heat exchangers. • Check short-circuiting of outdoor suction/discharge air. • Check clogging of SV2 circuit. • Check outdoor P.C. board (I/F) error. • Check indoor fan system error. (Cause of air volume decrease) • Check opening of indoor PMV. • Check miswiring of communication line between indoor and outdoor. • Check operation error of check valve of discharge pipe. • Check SV4 valve circuit. • Check SV5 valve circuit. • Check refrigerant overcharge.
P05	P05	00: — 01: Compressor 1 02: Compressor 2 03: Compressor 3	I/F	Open phase shortage/phase sequence detection Inverter DC voltage (Vdc) error (Compressor)	All stop	<ul style="list-style-type: none"> • Open phase was detected when the power turned on. • Overvoltage/Volt shortage was detected in inverter DC voltage 	<ul style="list-style-type: none"> • Check outdoor P.C. board (I/F) error.
P07	P07	01: Compressor 1 side 02: Compressor 2 side 03: Compressor 3 side	IPDU I/F	Heat sink overheat error	All stop	IGBT built-in temp sensor (TH) was overheated.	<ul style="list-style-type: none"> • Check power voltage. • Check outdoor fan system error. • Check clogging of heat sink cooling duct. • Check fixation between IGBT and heat sink. (Check screwing and contact.) • Check IPDU error.(IGBT built-in temp sensor (TH) error).
P10	P10	Indoor address with trouble	Indoor	Indoor overflow error	All stop	<ul style="list-style-type: none"> • Float switch operated. • Float switch circuit disconnected or the connector came off. 	<ul style="list-style-type: none"> • Check the float switch connector. • Check operation of drain pump unit. • Check the drain pump circuit. • Check clogging of drain pipe. • Check indoor P.C. board error.
P12	—	—	Indoor	Indoor fan motor error	Corresponding unit only stops.	<ul style="list-style-type: none"> • The value of motor speed deviated from target value was detected for certain time. • Over-current protection operated. 	<ul style="list-style-type: none"> • Check connection of fan connector and wiring. • Check fan motor error. • Check indoor P.C. board error. • Check influence of outside air control.

Wired remote controller	Check code		Detected position	Check code name	Status	Error detection condition	Check item (position)
	Outdoor 7-segment display						
	Check code	Auxiliary code					
P13	P13	—	I/F	Outdoor liquid back detection error	All stop	<p><In cooling> While the system operated in cooling mode, high status of high pressure value was detected in the stopped follower unit.</p> <p><In heating> While the system is operating in HEAT mode, outdoor PMV of which opening degree was 100 pulse or less for a certain time.</p>	<ul style="list-style-type: none"> • Check full close operation of outdoor PMV (1, 2, 4). • Check Pd and Ps sensor error. • Check clogging of SV2 circuit. • Check clogging of balance pipe. • Check clogging of SV3B circuit. • Check outdoor P.C. board (I/F) error. • Check capillary clogging of oil return circuit from oil separator. • Check leakage of stop valve in discharge assembly part.
P15	P15	01: TS condition	I/F	Gas leak detection (TS1 condition)	All stop	<p>Protective stop which generates when the status that suction temperature is over the judgment standard temperature continued for 10 minutes was repeated for 4 times or more.</p> <p><TS error judgment standard temperature> In cooling operation: 60°C or higher In heating operation: 40°C or higher</p>	<ul style="list-style-type: none"> • Check refrigerant shortage. • Check full open of outdoor service valves (gas side, liquid side). • Check outdoor PMV clogging (PMV1, 2). • Check characteristics of TS1 sensor resistance value. • Check 4-way valve error. • Check leakage of SV4 circuit.
		02: TD condition	I/F	Gas leak detection (TD condition)	All stop	<p>Protective stop which generates when the status that while compressor is under low frequency operation, the discharge temperature TD1, TD2 or TD3 detected 108°C or more continuously for 10 minutes was repeated for 4 times or more.</p>	<ul style="list-style-type: none"> • Check refrigerant shortage. • Check outdoor PMV clogging (PMV1, 2). • Check characteristics of TD1, TD2 sensor resistance value. • Check indoor air filter clogging. • Check pipe clogging. • Check SV4 circuit (Valve leakage, misinstallation)
P17	P17	—	I/F	Discharge temp TD2 error	All stop	<p>Protective stop which generates when the discharge temperature (TD2) was over 115°C was repeated for 4 times or more.</p>	<ul style="list-style-type: none"> • Check full opening of outdoor service valves (gas side, liquid side). • Check clogging of outdoor PMV (PMV1, 2, 4). • Check characteristics of TD2 sensor resistance value. • Check 4-way valve error. • Check leakage of SV4 circuit. • Check SV4 circuit. (Miscabling and misinstallation of SV41, SV42 and SV43)
P18	P18	—	I/F	Discharge temp. TD3 error	All stop	<p>Discharge temp. (TD3) exceeded 115°C.</p>	<ul style="list-style-type: none"> • Check full opening of outdoor service valve (gas side, liquid side). • Check clogging of outdoor PMV (PMV1, 2, 4) • Check characteristics of TD3 sensor resistance value. • Check 4-way valve error. • Check leakage of SV4 circuit. • Check SV4 circuit (Miswiring and mismounting of SV41, SV42, and SV43).
P19	P19	Detected outdoor unit No.	I/F	4-way valve operation error	All stop	<p>When abnormal refrigerating cycle data was detected in heating</p>	<ul style="list-style-type: none"> • Error of 4-way valve error. • Check coil error and connector connection of 4-way valve. • Check characteristics of TS1/TE1 sensor resistance value. • Check characteristics of Pd, Ps pressure sensor output voltage. • Check misconnection of TE1 and TL sensors.
P20	P20	—	I/F	High-pressure protective operation	All stop	<p>Pd sensor detected 3.6MPa or more.</p>	<ul style="list-style-type: none"> • Check Pd pressure sensor error. • Check full opening of service valves (Gas side, Liquid side). • Check outdoor fan error. • Check outdoor fan motor error. • Check clogging of outdoor PMV. (PMV1,2, 4) • Check clogging of indoor/outdoor heat exchangers. • Check air short-circuiting in outdoor unit. • Check clogging of SV2 circuit. • Check outdoor P.C. board (I/F) error. • Check indoor fan system error. (Cause of air volume decrease) • Check valve opening of indoor PMV. • Check miscabling of communication line between indoor and outdoor. • Check operation error of stop valve in discharge assembly part. • Check circuit of gas balance SV4 valve. • Check circuit of SV5 valve. • Check refrigerant overcharge.

Wired remote controller	Check code		Detected position	Check code name	Status	Error detection condition	Check item (position)
	Outdoor 7-segment display						
	Check code	Auxiliary code					
P22	P22	0*: IGBT circuit 1*: Output circuit error between each position 3*: Motor lock error 4*: Detection of motor current C*: TH sensor error D*: TH sensor error E*: Inverter DC voltage error (Outdoor unit fan) Note) In " * ", 0 to F is displayed, but ignore it.	IPDU	Outdoor fan IPDU error	All stop	(Auxiliary code: 08) Fan IPDU position detection circuit Position detection was not normally performed.	<ul style="list-style-type: none"> Fan motor check Connection check of connector for fan motor Error check of IPDU P.C. board for fan
					All stop	(Auxiliary code: 0A) Fan IPDU over-current protective circuit When the fan started and while it is operating, the status that current flows over constant flow was detected	<ul style="list-style-type: none"> Fan motor check Error check of IPDU P.C. board for fan
					All stop	(Auxiliary code: 0E) Fan IPDU position detection circuit Position detection was not normally performed.	<ul style="list-style-type: none"> Fan motor check Connection check of connector for fan motor Error check of IPDU P.C. board for fan
					All stop	(Auxiliary code: 0F) Fan IPDU position detection circuit Position detection was not normally performed.	<ul style="list-style-type: none"> Fan motor check Connection check of connector for fan motor Error check of IPDU P.C. board for fan
					All stop	(Auxiliary code: 06) External cause such as blast Position detection was not normally performed. (Restart after 6 seconds)	<ul style="list-style-type: none"> Fan motor check Connection check of connector for fan motor
					All stop	(Auxiliary code: 04) External cause such as blast When difference between target rpm and real rpm is 25% or more (Restart after 6 seconds)	<ul style="list-style-type: none"> Fan motor check Connection check of connector for fan motor
					All stop	(Auxiliary code: 0D) Fan IPDU position detection circuit Position detection was not normally performed. (Windless status)	<ul style="list-style-type: none"> Fan motor check Connection check of connector for fan motor Error check of IPDU P.C. board for fan
					All stop	(Auxiliary code: 0C) External cause such as blast Position detection was not normally performed. (Windy status) (Restart after 6 seconds)	<ul style="list-style-type: none"> Fan motor check Connection check of connector for fan motor
P26	P26	01: Compressor 1 side 02: Compressor 2 side 03: Compressor 3 side	IPDU	G-Tr short-circuit protection error	All stop	Instantaneous over-current was detected when compressor started.	<ul style="list-style-type: none"> Check connector connection and wiring on Comp. IPDU P.C. board. Check compressor error and defect of compressor coil. Check outdoor P.C. board (Comp. IPDU) error.
P29	P29	01: Compressor 1 side 02: Compressor 2 side 03: Compressor 3 side	IPDU	Compressor position detection circuit error	All stop	Position was not normally detected.	<ul style="list-style-type: none"> Check connector connection and wiring. Check compressor error and defect of compressor coil. Check P.C. board (Comp. IPDU) error.
P31	—	—	Indoor	Other indoor error (Group follower unit error)	Corresponding unit only stops.	E07/L07/L03/L08 was detected when other indoor unit in the group was defective.	<ul style="list-style-type: none"> Check indoor P.C. board.

Error detected by TCC-LINK central control device

Display on central control device	Check code		Detected position	Check code name	Status	Error detection condition	Check item (position)
	Outdoor 7-segment display						
	Check code	Auxiliary code					
C05	—		TCC-LINK	TCC-LINK central control device transmission error	Operation continued.	Signal is not transmit from central control device.	<ul style="list-style-type: none"> • Check central control device error. • Check communication line error of central control device. • Check setup of terminator resistor.
C06	—			TCC-LINK central control device transmission error	Operation continued.	Signal is not received from central control device.	<ul style="list-style-type: none"> • Check central control device error. • Check communication line error of central control device. • Check setup of terminator resistor. • Check the power of connecting destination connected device. • Check P.C. board error of the connected device.
C12	—		General-purpose equipment I/F	General-purpose controller control Interface batched alarm	Operation continued.	Error was input in general-purpose equipment control interface.	<ul style="list-style-type: none"> • Check error input.
P30	Differs according to error contents of the with alarm		TCC-LINK	Follower unit error of group control	Operation continued.	An error occurred in follower unit of the group control. ([P30] is displayed only on the central remote controller.)	<ul style="list-style-type: none"> • Check the check code of the unit with alarm.
	(L20 is displayed.)			Duplicated central control address	Operation continued.	Central control addresses were duplicated.	<ul style="list-style-type: none"> • Check the address setup.

10-4-1. Cautions When Servicing for Compressor

1. Removing wires of both compressors check output of the inverter as described below.

10-4-2. How to Check Inverter Output

1. Turn off the power supply.
2. Remove the compressor lead cables from the compressors.
(Be sure to remove lead cables of both compressors.)
3. Turn on the power supply and start cooling or heating operation.
In this time, pay attention to touch the fasten receptacle terminal lug of the compressor leads so that they do not contact with other fasten receptacle terminal lug or other position (unit cabinet, etc.).
4. Check output voltage of compressor lead cable at inverter side.

When the output voltage does not satisfy the criteria in the following table, replace IPDU P.C. board.

No.	Measured position	Criteria
1	Between Red and White	400 V to 650 V
2	Between White and Black	400 V to 650 V
3	Between Black and Red	400 V to 650 V

* After checking the output, when connecting the compressor lead again to the compressor terminal, check surely there is no distortion on the fasten terminal lug. If it is loosened, caulk it with pinchers, etc and then connect lead to the terminal.

10-4-3. How to Check Resistance of Compressor Winding

1. Turn off the power supply.
2. Remove the compressor lead cables from the compressors.
In each compressor, check the winding resistance between phases and resistance of the outdoor cabinet using a tester.
 - Is not it earthed?
→ Normal if 10MΩ or more are measured
 - Is not shorted between windings?
→ Normal if 0.7Ω to 0.9Ω are measured (Use a precise digital tester.)

10-4-4. How to Check the External Fan Motor

1. Turn off the power supply.
2. Take off three connectors (U.V.W) from the external fan IPDU P.C. board.
3. Turn the fan with hands. If the fan does not turn, it is a fan motor error (Lock). Replace the fan motor.
If the fan turns, measure the winding resistance between the phases of the connector (Motor winding) with a tester. If 13 to 33Ω are measured, it is normal. (Use a digital tester.)

10-5. Sensor characteristics

■ Temperature sensor characteristics

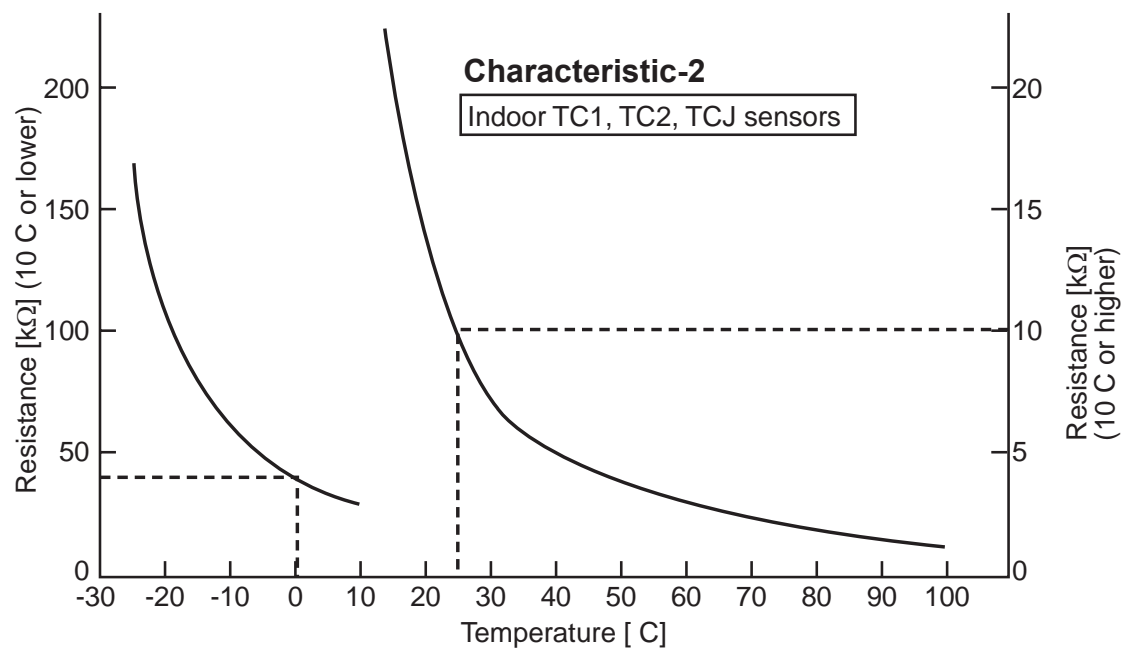
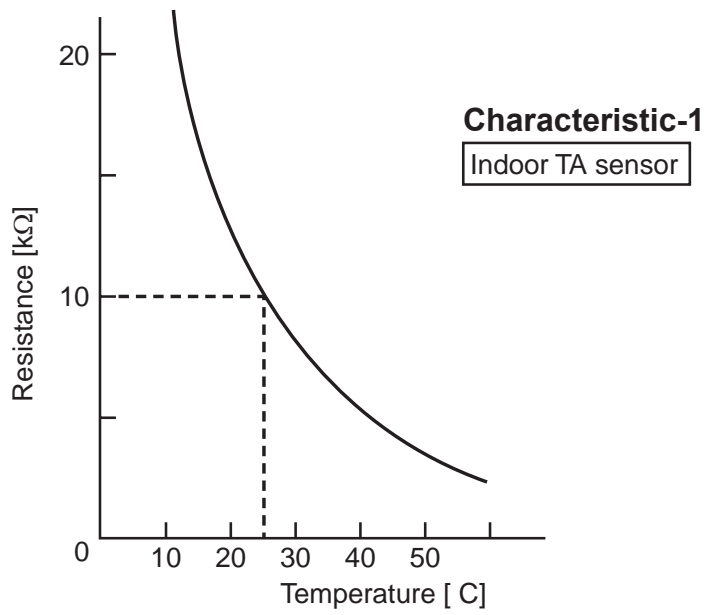

11. Owners Manual (for wireless remote controller)

Original instructions

Thank you very much for purchasing TOSHIBA Air Conditioner.
Please read this owner's manual carefully before using your Air Conditioner.

- Be sure to obtain the "Owner's manual" and "Installation manual" from constructor (or dealer).
Request to constructor or dealer
- Please clearly explain the contents of the Owner's manual and hand over it.

NOTE

This manual describes operations of the indoor unit and the wireless remote controller.
For details of the wired remote controller and the outdoor unit, refer to the operation manual supplied with the outdoor unit. (Keep these manuals carefully.)

ADOPTION OF NEW REFRIGERANT

This Air Conditioner is a new type which adopts a new refrigerant HFC (R410A) instead of the conventional refrigerant R22 in order to prevent destruction of the ozone layer.

This appliance is not intended for use by person (including children) with reduced physical, sensory or mental capabilities, or lack of experience and knowledge, unless they have been given supervision or instruction concerning use of the appliance by a person responsible for their safety.

Contents

1	PRECAUTIONS FOR SAFETY	4
2	ACCESSORIES	7
3	PARTS NAME	7
4	PARTS NAME OF REMOTE CONTROLLER	9
5	ADJUSTING CLOCK	11
6	LIMITED OPERATION BY GROUP CONTROL	12
7	HANDLING THE REMOTE CONTROLLER	13
8	HOW TO USE REMOTE CONTROLLER	13
9	HINTS FOR ECONOMICAL OPERATION	19
10	TEMPORARY OPERATION	20
11	MAINTENANCE	20
12	SPECIFICATIONS	22

Thank you for purchasing this Toshiba air conditioner.
Please read carefully through these instructions that contain important information which complies with the "Machinery" Directive (Directive 2006/42/EC), and ensure that you understand them.
Some of the details provided in these instructions differ from the Owner's Manual supplied with your product, and the instructions provided here take precedence.
After reading these instructions, be sure to keep them in a safe place together with the Owner's Manual and Installation Manual supplied with your product.



Generic Denomination : Air Conditioner

Definition of Qualified Installer or Qualified Service Person

The air conditioner must be installed, maintained, repaired and removed by a qualified installer or qualified service person. When any of these jobs is to be done, ask a qualified installer or qualified service person to do them for you. A qualified installer or qualified service person is an agent who has the qualifications and knowledge described in the table below.

Agent	Qualifications and knowledge which the agent must have
Qualified installer	<ul style="list-style-type: none"> • The qualified installer is a person who installs, maintains, relocates and removes the air conditioners made by Toshiba Carrier Corporation. He or she has been trained to install, maintain, relocate and remove the air conditioners made by Toshiba Carrier Corporation or, alternatively, he or she has been instructed in such operations by an individual or individuals who have been trained and is thus thoroughly acquainted with the knowledge related to these operations. • The qualified installer who is allowed to do the electrical work involved in installation, relocation and removal has the qualifications pertaining to this electrical work as stipulated by the local laws and regulations, and he or she is a person who has been trained in matters relating to electrical work on the air conditioners made by Toshiba Carrier Corporation or, alternatively, he or she has been instructed in such matters by an individual or individuals who have been trained and is thus thoroughly acquainted with the knowledge related to this work. • The qualified installer who is allowed to do the refrigerant handling and piping work involved in installation, relocation and removal has the qualifications pertaining to this refrigerant handling and piping work as stipulated by the local laws and regulations, and he or she is a person who has been trained in matters relating to refrigerant handling and piping work on the air conditioners made by Toshiba Carrier Corporation or, alternatively, he or she has been instructed in such matters by an individual or individuals who have been trained and is thus thoroughly acquainted with the knowledge related to this work. • The qualified installer who is allowed to work at heights has been trained in matters relating to working at heights with the air conditioners made by Toshiba Carrier Corporation or, alternatively, he or she has been instructed in such matters by an individual or individuals who have been trained and is thus thoroughly acquainted with the knowledge related to this work.
Qualified service person	<ul style="list-style-type: none"> • The qualified service person is a person who installs, repairs, maintains, relocates and removes the air conditioners made by Toshiba Carrier Corporation. He or she has been trained to install, repair, maintain, relocate and remove the air conditioners made by Toshiba Carrier Corporation or, alternatively, he or she has been instructed in such operations by an individual or individuals who have been trained and is thus thoroughly acquainted with the knowledge related to these operations. • The qualified service person who is allowed to do the electrical work involved in installation, repair, relocation and removal has the qualifications pertaining to this electrical work as stipulated by the local laws and regulations, and he or she is a person who has been trained in matters relating to electrical work on the air conditioners made by Toshiba Carrier Corporation or, alternatively, he or she has been instructed in such matters by an individual or individuals who have been trained and is thus thoroughly acquainted with the knowledge related to this work. • The qualified service person who is allowed to do the refrigerant handling and piping work involved in installation, repair, relocation and removal has the qualifications pertaining to this refrigerant handling and piping work as stipulated by the local laws and regulations, and he or she is a person who has been trained in matters relating to refrigerant handling and piping work on the air conditioners made by Toshiba Carrier Corporation or, alternatively, he or she has been instructed in such matters by an individual or individuals who have been trained and is thus thoroughly acquainted with the knowledge related to this work. • The qualified service person who is allowed to work at heights has been trained in matters relating to working at heights with the air conditioners made by Toshiba Carrier Corporation or, alternatively, he or she has been instructed in such matters by an individual or individuals who have been trained and is thus thoroughly acquainted with the knowledge related to this work.

Warning Indications on the Air Conditioner Unit

Warning indication		Description
	WARNING ELECTRICAL SHOCK HAZARD Disconnect all remote electric power supplies before servicing.	WARNING ELECTRICAL SHOCK HAZARD Disconnect all remote electric power supplies before servicing.
	WARNING Moving parts. Do not operate unit with grille removed. Stop the unit before the servicing.	WARNING Moving parts. Do not operate unit with grille removed. Stop the unit before the servicing.
	CAUTION Do not touch the aluminum fins of the unit. Doing so may result in injury.	CAUTION Do not touch the aluminum fins of the unit. Doing so may result in injury.

1 PRECAUTIONS FOR SAFETY

The manufacturer shall not assume any liability for the damage caused by not observing the description of this manual.



General

- Carefully read Owner's Manual before starting the air conditioner. There are many important things to keep in mind for daily operation.
- Do not use any refrigerant different from the one specified for complement or replacement. Otherwise, abnormally high pressure may be generated in the refrigeration cycle, which may result in a failure or explosion of the product or an injury to your body.

Transportation and storage

- When transporting the air conditioner, wear shoes with additional protective toe caps.
- When stacking the packing cartons for storage or transportation, heed the precautions written on the packing cartons. Failure to heed the precautions may cause the stack to collapse.
- When transporting the air conditioner, transport it by two people or more.

Installation

- Only a qualified installer(*1) or qualified service person(*1) is allowed to install the air conditioner. If the air conditioner is installed by an unqualified individual, a fire, electric shocks, injury, water leakage, noise and/or vibration may result.
- After the installation work has been completed, have the installer explain about the circuit breaker positions. In the event that trouble has occurred in the air conditioner, set the circuit breaker to the OFF position, and contact a service person.
- If you install the unit in a small room, take appropriate measures to prevent the refrigerant from exceeding the limit concentration even if it leaks. Consult the dealer from whom you purchased the air conditioner when you implement the measures. Accumulation of highly concentrated refrigerant may cause an oxygen deficiency accident.
- Do not install the air conditioner in a location that may be subject to a risk of exposure to a combustible gas. If a combustible gas leaks and becomes concentrated around the unit, a fire may occur.

Operation

- Before opening the front panel of the indoor unit or service panel of the outdoor unit, set the circuit breaker to the OFF position. Failure to set the circuit breaker to the OFF position may result in electric shocks through contact with the interior parts. Only a qualified installer(*1) or qualified service person(*1) is allowed to remove the front panel of the indoor unit or service panel of the outdoor unit and do the work required.
- Inside the air conditioner are high-voltage areas and rotating parts. Due to the danger of electric shocks or of your fingers or physical objects becoming trapped in the rotating parts, do not remove the front panel of the indoor unit or service panel of the outdoor unit. When work involving the removal of these parts is required, contact a qualified installer or a qualified service person.
- Do not move or repair any unit by yourself. Since there is high voltage inside the unit, you may get electric shock when removing the cover and main unit.
- Never insert a stick into the air intake or outlet. Doing so may result injury as the fan is rotating at high speed inside the unit.
- Do not expose your body to cool air directly for a long time and do not cool yourself excessively. Doing so may result in deteriorated physical condition and ill health.
- Do not touch the aluminum fin of the unit. You may injure yourself if you do so. If the fin must be touched, do not touch it yourself but contact a qualified installer or a qualified service person.
- Do not spill water or other liquid on the indoor unit. If the unit is wet, it may cause an electric shock.
- Do not place any combustion appliance in a place where it is directly exposed to the wind of air conditioner, otherwise it may cause imperfect combustion.
- When the air conditioner is operated with a combustion appliance in the same place, be careful of ventilation to let fresh air enter the room. Poor ventilation causes oxygen shortage.
- When the air conditioner is used in a closed room, be careful of sufficient ventilation of the room. Poor ventilation causes oxygen shortage.

Repairs

- When you have noticed that some kind of trouble (such as when an error display has appeared, there is a smell of burning, abnormal sounds are heard, the air conditioner fails to cool or heat or water is leaking) has occurred in the air conditioner, do not touch the air conditioner yourself but set the circuit breaker to the OFF position, and contact a qualified service person. Take steps to ensure that the power will not be turned on (by marking "out of service" near the circuit breaker, for instance) until qualified service person arrives. Continuing to use the air conditioner in the trouble status may cause mechanical problems to escalate or result in electric shocks, etc.
- If you have discovered that there is a danger of the indoor unit's falling, do not approach the indoor unit but set the circuit breaker to the OFF position, and contact a qualified installer or a qualified service person to refit the unit. Do not set the circuit breaker to the ON position until the unit has been refitted.
- Do not modify the products. Do not also disassemble or modify the parts. It may cause a fire, electric shock or injury.

Relocation

- When the air conditioner is to be relocated, do not relocate it yourself but contact a qualified installer or a qualified service person. Failure to relocate the air conditioner properly may result in electric shocks and/or a fire.

(*1) Refer to the "Definition of Qualified Installer or Qualified Service Person."

⚠ CAUTION

CAUTIONS ABOUT INSTALLATION









- Certainly lay the drain hose for perfect draining.
Wrong drainage may cause flooding in the house and getting furniture wet.
- Make sure to connect the air conditioner to an exclusive power supply of the rated voltage; otherwise, the unit may break down or cause a fire.

CAUTIONS ABOUT OPERATION

- Carefully read this manual and the manual supplied with the outdoor unit before starting the air conditioner. The manual includes many important things for daily operation.
- Do not use this air conditioner for other purposes such as preserving food, precision instruments, art objects, breeding animals, growing potted plants, etc.
- Do not install this air conditioner in a special-purpose room such as a ship or any kind of vehicle, otherwise it deteriorates the machine performance.
- Avoid exposing potted plants and animals to wind of the air conditioner, because it badly affects the health and growing of them.
- When the air conditioner is operated together with a combustion appliance in the same place, be careful of ventilation to let fresh air into the room.
Poor ventilation causes oxygen shortage.
- Do not touch operation button with wet finger; otherwise, you may get an electric shock.
- When the air conditioner won't be used for a considerably long time, turn off the main switch or the circuit breaker, for safety. Disconnection from the power supply prevents the unit from lightning and power source surge.
- Do not put a vessel with water such as a vase on the unit, because water may possibly sink into the unit and will bring about electric shock because of deterioration in electric insulation.
- Do not wash the unit with water. It may cause an electric shock.
- Do not use alcohol, benzene, thinner, glass cleaner, polishing powder, etc. for cleaning the unit, because they deteriorate or damage the air conditioner.
- When cleaning the unit, make sure to turn off the main switch or circuit breaker beforehand for preventing you from getting injured by the electric fan running inside.
For details of cleaning method, refer to "Maintenance".
- To make the air conditioner demonstrate its original performance, operate it within the range of the operating temperature specified in the instructions.
Otherwise it may malfunction, break down or water may leak from the unit.

Information on the Transportation, Handling and Storage of the Carton

Examples of indication on the carton

Symbol	Description	Symbol	Description
	Keep dry		Handle with care
 FRAGILE	Fragile	 DO NOT DROP	Do not drop
 8 cartons	Stacking height (9 cartons can be stacked in this case)	 DO NOT LAY DOWN	Do not lay down
	This side up		Do not step

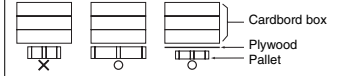
Other cautions	Description
<p>Stacking notice.</p> <p>In case that cardboard boxes protrude out of pallet when stacking, lay a 10 mm thick plywood over the pallet.</p>  <p>Cardbord box Plywood Pallet</p>	<p>Stacking notice. In case that cardboard boxes protrude out of pallet when stacking. Lay a 10 mm thick plywood over the pallet.</p>

2 ACCESSORIES

Remote controller

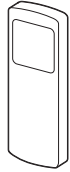

Remote controller holder



Batteries (two)



3 PARTS NAME

Indoor unit

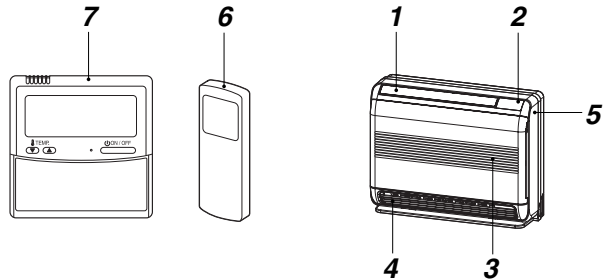

- 1 Upper air outlet grille
- 2 Main operation part
- 3 Air inlet grille
- 4 Lower air outlet grille
- 5 Front panel
- 6 Remote controller (wireless)
- 7 Remote controller (wired, sold separately)

Names and functions of indicators and controls on indoor unit

Display panel

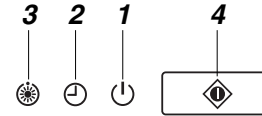

The operating conditions are indicated below.

1 OPERATION (Green)

This lamp goes on during operation.

2 TIMER (Green)

This lamp goes on white the timer reserved.

NOTE

In case of timer setting by wired remote controller, TIMER lamp does not light.

In case of group control, TIMER lamp goes on header unit only. (see "6 LIMITED OPERATION BY GROUP CONTROL")

3 Preheat/Defrost (Orange)

This lamp lights up when the power is turned on or right after heating operation starts or during defrost operation.

CAUTION

Disagreement in operation mode

If you select AUTOMATIC OPERATION in a model with no auto-changeover (cooling/heating) control setting or if you select HEAT in a Cool Only model, an alarm sound (pi, pi) from the air conditioner due to disagreement in operation mode. Change the operation mode with the MODE button on the wireless remote controller. This disagreement indication cannot be deleted by the wired remote controller.

- When local prohibition is set by the central control from other equipment, no signal is received even if the remote controller button is pressed. However, a signal of START/STOP button is accepted. (An alarm sound "pi" arises intermittently five times.)

4 TEMPORARY operation

If you misplace or lose the wireless remote controller or its batteries are exhausted, push the button.

- Push the button to start the air conditioner. Push this button once again to stop it.

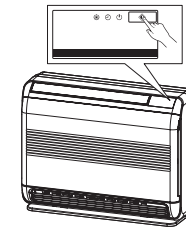

4 PARTS NAME OF REMOTE CONTROLLER

■ Wireless remote controller and its functions

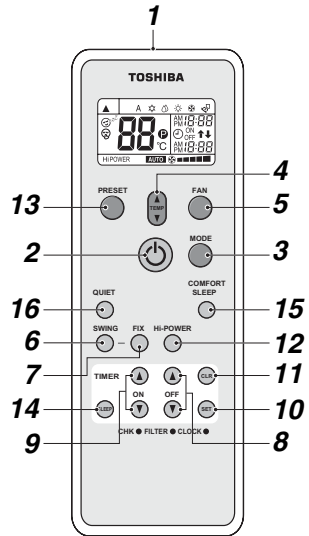

1 Infrared signal emitter

Transmits a signal to the indoor unit.

2 START/STOP button

Press the button to start operation.

(A receiving beep is heard.)

Press the button again to stop operation.

(A receiving beep is heard.)

If no receiving sound is heard from the indoor unit, press the button twice.

3 Mode select button (MODE)

Press this button to select a mode.

Each time you press the button, a mode is selected in a sequence that goes from A : Auto changeover control, ❄️ : Cool, ☀️ : Dry, 🔥 : Heat, 🌀 : Fan only, and back to A. (A receiving beep is heard.)

4 Temperature button

..... The set temperature is increased up to 30°C.

..... The set temperature is dropped down to 17°C. (A receiving beep is heard.)

5 Fan speed button (FAN)

Press this button to select fan speed. When you select AUTO, the fan speed is automatically adjusted according to the room temperature.

You can also manually select the desired fan speed from among five settings.

(LOW ■■■, LOW* ■■■■, MED ■■■■■, MED* ■■■■■■, HIGH ■■■■■■■■)

(A receiving beep is heard.)

6 Auto louver button (SWING)

Press this button to swing the louver.

(A receiving beep is heard.)

Press the SWING button to stop the louver swinging.

(A receiving beep is heard.)

7 Set louver button (FIX)

Press this button to adjust the airflow direction.

(A receiving beep is heard.) While this button is kept depressed, the receiving tone continuously sounds.

8 Off timer button (OFF)

Press this button to set the OFF timer.

9 On timer button (ON)

Press this button to set the ON timer.

10 Reserve button (SET)

Press this button to reserve time settings.

(A receiving beep is heard.)

11 Cancel button (CLR)

Press this button to cancel ON timer and OFF timer.

(A receiving beep is heard.)

12 High power button (Hi-POWER)

Press this button to start the high power operation.

This function is not operated group control.

13 PRESET button

Press this button to change the operation mode to the preferred operation mode memorized previously.

To memorize the operation mode, press this button for at least 3 seconds during the preferred operation mode. Ⓜ️ is displayed and the operation mode is memorized.

14 SLEEP button

Press this button to start the OFF timer operation that automatically adjusts the room temperature and the fan speed.

You can select the OFF timer time from four durations (1, 3, 5 or 9 hours).

15 COMFORT SLEEP button

Press this button to start the OFF timer operation that automatically adjusts the room temperature and the fan speed.

You can select the OFF timer time from four durations (1, 3, 5 or 9 hours).

During group control operation, the set temperature and the fan speed are not automatically adjusted.

Only off timer function is activated.

16 QUIET button

Press this button to start quiet operation.

Pressing this button again will restore normal operation.

■ Names and functions of indications on wireless remote controller

Display

All indications, except for clock time indication, are indicated by pressing the START/STOP button.

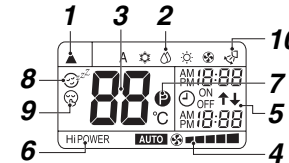

- In the illustration, all indications are indicated for explanation. During operation, only the relevant indications will be indicated on the remote controller.

1 Transmission mark

This transmission mark (▲) indicates when the remote controller transmits signals to the indoor unit.

2 Mode display

Indicates the current operation mode.

(A : Auto changeover control, ❄️ : Cool, ☀️ : Dry, 🔥 : Heat, 🌀 : Fan only)

3 Temperature display

Indicates the temperature setting (17°C to 30°C). When you set the operating mode to 🌀 : Fan only, no temperature setting is indicated.

4 FAN speed display

Indicates the selected fan speed. AUTO or one of five fan speed levels (LOW ■■■, LOW* ■■■■, MED ■■■■■, MED* ■■■■■■, HIGH ■■■■■■■■) can be indicated.

Indicates **AUTO** when the operating mode is ☀️ : Dry.

5 TIMER and clock time display

The time set for timer operation or clock time is indicated.

The present time is always indicated except for TIMER operation.

6 Hi-POWER display

Indicates when the high power operation starts. Press the Hi-POWER button to start and press it again to stop the operation.

7 (PRESET) display

Indicated when memorizing the preferred operation mode or when it has been memorized. Also, this icon is indicated when the memorized preferred operation is displayed.

8 (COMFORT SLEEP) display

Indicated during the OFF timer operation that automatically adjusts the room temperature and the fan speed. Each time you press the COMFORT SLEEP button, the display changes in the sequence of 1h, 3h, 5h, and 9h.

9 (QUIET) display

Indicated during the quiet operation.

10 Swing display

Indicated during the swinging operation where the horizontal louver automatically moves up and down.

NOTE

When both wired remote controller and wireless remote controller are used, display on the screen of wireless remote controller may differ from the actual operation in some cases.

■ Preparation and check before use

1. Loading Batteries

- Remove the battery cover.
- Insert 2 new batteries (R03 [AAA]) following the (+) and (-) positions.

2. Removing Batteries

- Remove the battery cover.
- Remove the 2 used batteries.

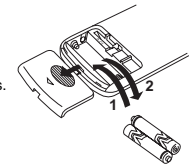

Batteries

- To replace the batteries, use two new batteries (R03 [AAA]).
- In normal use, the batteries will last about one year.
- Replace the batteries if there is no receiving beep from the indoor unit or when the air conditioner cannot be operated using the remote controller.
- To avoid malfunctions by battery leakage, remove the batteries when not using the remote controller for more than one month.
- Please dispose of the used batteries according to the local regulation.

5 ADJUSTING CLOCK

Setting the clock

Before you start operating the air conditioner, set the clock of the remote controller using the procedures given in this section. The clock panel on the remote controller will indicate the time regardless of whether the air conditioner is in use or not.

Initial setting

When batteries are inserted in the remote controller the clock panel will indicate AM 0:00 and will flash.

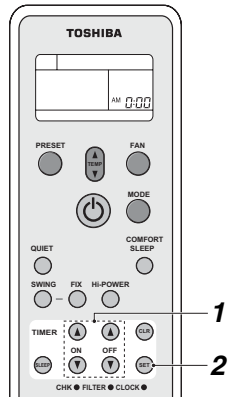

1 TIMER button

Press the TIMER button to set the current time. Each press of the TIMER button changes the time in one minute steps. Pressing the TIMER button continually changes the time in ten minute steps.

2 SET button

Press the SET button. The current time is indicated and the clock starts.

■ Clock adjusting

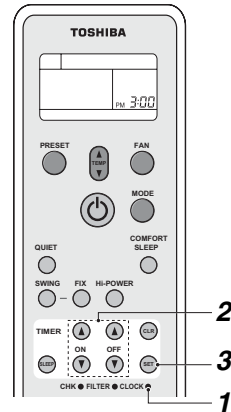

1 CLOCK button

Press the CLOCK button by tip of a pencil. The CLOCK display flashes.

2 TIMER button

Press the TIMER button to set the current time. Each press of the TIMER button changes the time by one minute. Pressing the TIMER button continually changes the time by ten minutes.

3 SET button

Press the SET button. The current time is indicated and the clock starts.

6 LIMITED OPERATION BY GROUP CONTROL

NOTE

Group control: Operate air conditioners in more than one system in same time.
Header indoor unit: The representative unit during group control. Receive commands from wired remote controller and transmit the commands to follower units.
(Header indoor unit is indoor units that receives START/STOP signal from the wireless remote control.)
Follower indoor unit: Indoor units other than the Header unit are called follower unit.
A wired remote controller (separately available) is required for the group control.

▼ Example of group combination

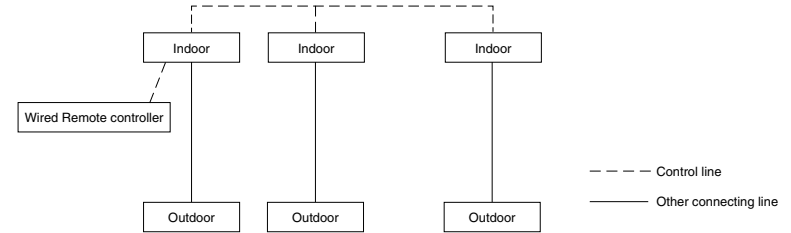

CAUTION

When using indoor unit in group control,

1. Hi-POWER operation will not function.

When Hi-POWER is transmitted from wireless remote controller the receiving sound will be heard from the indoor unit and display on the wireless remote controller will also change. However, the indoor unit does not operate Hi-POWER operation. Restore the display on the wireless remote controller pushing Hi-POWER button.

2. COMFORT SLEEP

When COMFORT SLEEP is transmitted from wireless remote controller, the receiving sound will be heard from the indoor unit and the display on the wireless remote controller will also be changed as same as Hi-POWER operation. However, the set temperature and the fan speed will not be automatically adjusted. Only off timer function is activated.

3. Units other than the Header unit cannot be operated with remote controller and the TEMPORARY operation.

When operating air conditioner with wireless remote controller transmission should be sent to the Header unit. Header and follower indoor units are decided through address setting upon installation. Follower unit will not receive any signals from wireless remote controller.

Air conditioner will not work even if the button on the follower unit is pressed.

(Some Follower units may receive SWING and FIX, but these operations are performed only on the unit that received the signal.)

(When wireless remote controller is used, only the Header unit receives SWING signal. If the SWING signal is transmitted to follower unit, the sound to refuse receiving signal (3 beeps) is heard and the follower unit does not receive the signal.

For FIX operation, both Header and follower unit perform the operation by itself.

When wired remote controller is used, airflow direction can be changed on each unit by selecting the indoor unit.)

4. TIMER lamp lights up only on the Header unit.

When the timer is set with wired remote controller, even the TIMER lamp on the Header unit will not light up.

7 HANDLING THE REMOTE CONTROLLER

CAUTION

- The air conditioner will not operate if curtains, doors or other materials block the signals from the remote controller to the indoor unit.
- Prevent any liquid from falling into the remote controller.
Do not expose the remote controller to direct sunlight or heat.
- If the infrared signal receiver on the indoor unit is exposed to direct sunlight, the air conditioner may not function properly.
Use curtains to prevent the sunlight from reaching the receiver.
- If the room using the air conditioner has fluorescent lighting with electronic starters, signals may not be properly received. If you are planning to use such fluorescent lamps, consult your local dealer.
- If other electrical appliances react to the remote controller move these appliances or consult your local dealer.

Location of the remote controller

- Keep the remote controller where its signals can reach the receiver of the indoor unit (a distance of 7 m is allowed).
- When you select the timer operation, the remote controller automatically transmits a signal to the indoor unit at the specified time.
If you keep the remote controller in a position that hinders proper signal transmission, a time lag of up to 15 minutes may occur.

Remote controller holder

Installing the remote controller holder

- Before you actually install the remote controller holder on a wall or pillar, check whether the remote controller signals can be received by the indoor unit.

Mounting and removing the remote controller

- To mount the remote controller hold it parallel to the remote controller holder and push it in fully.
To remove the remote controller slide the remote controller upwards and out from the holder.

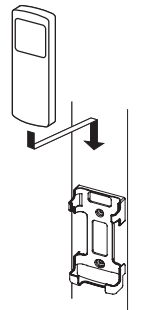

8 HOW TO USE REMOTE CONTROLLER

Cooling/heating/fan only operation

Start

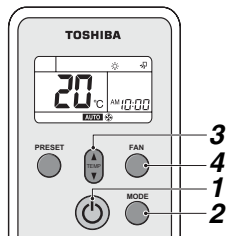

- START/STOP button (⏻)**
Press this button to start the air conditioner.
- Mode select button (MODE)**
Select Cool ❄️, Heat 🔥, or Fan only 🌀.
- Temperature button (🌡️)**
Set the desired temperature.
When the air conditioner is in FAN ONLY operation, the temperature display is not indicated.

4 Fan speed button (FAN)

Select one of **AUTO** LOW ■■■, MED ■■■■, MED* ■■■■■, HIGH ■■■■■■.

- The OPERATION lamp (green) on the display panel of the indoor unit goes on. And operation starts after approximately 3 minutes. (If you select FAN ONLY mode, the unit will start immediately.)
- The 🌀 : Fan only mode does not control temperature.
- Fan speed **AUTO** is the same as HIGH ■■■■■■. Therefore, perform only steps 1, 2 and 4 to select this mode.

Stop

START/STOP button (⏻)
Press this button again to stop the air conditioner.

NOTE

- When the indoor unit is operated together with a cooling only outdoor model outdoor unit, ❄️ appears on the remote controller but the heating operation is disabled.
- In the cooling operation, airflow is blown out only from the upper air outlet grille under some operating conditions.

Dry operation

Start

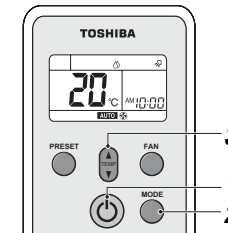

- START/STOP button (⏻)**
Press this button to start the air conditioner.
- Mode select button (MODE)**
Select DRY ☁️.
- Temperature button (🌡️)**
Set the desired temperature.

- The fan speed display indicates **AUTO**.
- The OPERATION lamp (green) on the display panel of the indoor unit lights, and operation starts after approximately 3 minutes.

Stop

START/STOP button (⏻)
Press this button again to stop the air conditioner.

NOTE

In the dry operation, airflow is blown out only from the upper air outlet grille.

Automatic operation (auto changeover)

This function is available only for use in combination with a heat recovery model outdoor unit. If this function is used with another model of outdoor unit, "A" (Auto) appears on the remote controller but the automatic operation is disabled.

Start

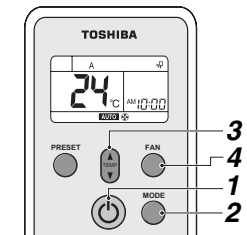

- START/STOP button (⏻)**
Press this button to start the air conditioner.
- Mode select button (MODE)**
Select A.
- Temperature button (🌡️)**
Set the desired temperature.
- Fan speed button (FAN)**
Select one of **AUTO** LOW ■■■, LOW* ■■■■, MED ■■■■, MED* ■■■■■, HIGH ■■■■■■.

- The OPERATION lamp (green) on the display panel of the indoor unit lights.
The operating mode is selected in accordance with the room temperature and operation starts after approximately 3 minutes.
- If the "A" mode is uncomfortable, you can select the desired conditions manually.

Stop

START/STOP button (⏻)
Press this button again to stop the air conditioner.

■ Timer operation

Use the wired remote controller for timer setting if it is also in use.

ON timer and OFF timer

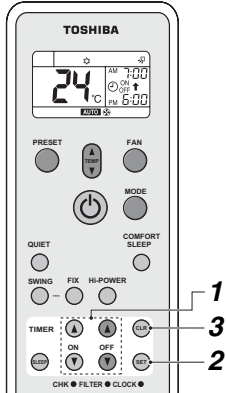

Setting TIMER

1 ON/OFF TIMER button (ON or OFF)

- Press the ON or OFF TIMER buttons as required.
- The previous timer setting is displayed and flashes along with ON/OFF timer display.
- Set the timer to the desired time.
- Each press of the TIMER button changes the time in ten minute steps.
- Pressing the TIMER button continually changes the time in one hour step.

2 SET button

- Press the SET button to set the timer.
- The timer time is indicated and the timer starts.

Cancelling TIMER

3 CLR button

- Press the CLR button to cancel the timer setting.

⚠ CAUTION

- When you select the timer operation, the remote controller automatically transmits the timer signal to the indoor unit at the specified time. Therefore, keep the remote controller in a location where it can transmit the signal to the indoor unit properly. Otherwise, the time lag of up to 15 minutes will occur.
- If you do not press the SET button within 30 seconds after setting the time, the setting will be cancelled.

Once you select the timer operation mode, the settings are saved in the remote controller. Thereafter, the air conditioner will start operating under the same conditions when you simply press the ON/OFF button of the remote controller.

If the clock display is flashing, you cannot set the timer. Follow the instructions in the section "SETTING THE CLOCK" and then set the timer.

Combined timer (Setting both ON and OFF timers simultaneously)

OFF timer → ON timer (Operation → Stop → Operation)

This feature is useful when you want to stop the air conditioner after you go to sleep, and start it again in the morning when you wake up or you return home.

Example :

To stop the air conditioner and start it again next morning.

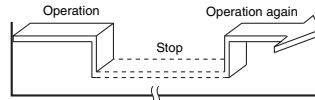

▼ Setting combined TIMER

- Press the OFF TIMER button to adjust the OFF timer.
- Press the ON TIMER button to adjust the ON timer.
- Press the SET button.

ON timer → OFF timer

(Stop → Operation → Stop)

You can use this setting to start the air conditioner when you wake up and stop it when you leave the house.

Example :

To start the air conditioner next morning and stop it.

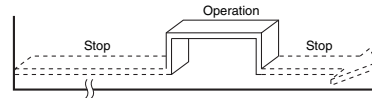

▼ Setting combined TIMER

- Press the ON TIMER button to adjust the ON timer.
- Press the OFF TIMER button to adjust the OFF timer.
- Press the SET button.

- Either ON or OFF timer function which is closer to the current time, is activated first.
- If the same time is set for both ON and OFF timers, no timer operation is performed. Also, the air conditioner may stop operating.

Every day combined timer (setting both ON and OFF timer simultaneously and activate every day.)

This feature is useful when you want to use combined timer at the same time every day.

▼ Setting combined TIMER

- Press the ON TIMER button to adjust the ON timer.
- Press the OFF TIMER button to adjust the OFF timer.
- Press the SET button.
- After step 3, an arrow mark (↑ or ↓) flashes for about 3 seconds and during this flashing, press the SET button.

- During the every day timer is activating, both arrows (↑ ↓) are indicated.

Cancel the timer operation

Press the CLR button.

Clock display

During the TIMER operation (ON-OFF, OFF-ON, OFF timer) clock display is disappeared so as to show the setting time. To see the present time, press SET button briefly and the present time is displayed about 3 seconds.

■ High power operation

High power (Hi-POWER)

- The Hi-POWER (high power operation) mode automatically controls room temperature, airflow and operation mode so that the room is quickly cooled in summer and warmed in winter.

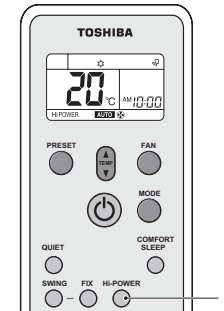

Setting Hi-POWER mode

1 Hi-POWER button

Press the Hi-POWER button after starting any operation. At the same time, the "Hi-POWER" mark on the remote controller is indicated.

Cancelling Hi-POWER mode

1 Hi-POWER button

Press the Hi-POWER button once again. At the same time, the "Hi-POWER" mark on the remote controller goes out.

⚠ CAUTION

- The Hi-POWER mode cannot be activated in the DRY and FAN ONLY operation and when the ON TIMER operation is reserved.
- Hi-POWER mode is not available for group control. When Hi-POWER is transmitted to the Header indoor unit, the receiving sound is heard but the Hi-POWER mode will not be performed. Please cancel the Hi-POWER mode.

■ Quiet operation

- The QUIET mode provides quiet operating status by automatically setting the fan speed to the lowest speed.

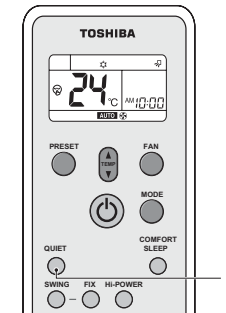

Setting QUIET mode

1 QUIET button

Press the QUIET button after starting any operation. At the same time, the QUIET mark is indicated.

Cancelling QUIET mode

1 QUIET button

Press the QUIET button once again. At the same time, the QUIET mark on the remote controller disappears.

⚠ CAUTION

The QUIET mode cannot be activated in the DRY operation.

NOTE

Under certain conditions, the quiet operation may not provide adequate cooling or heating due to the feature of quietness.

■ Preset Operation

Set your preferred operation mode for future use. The setting is memorized by the unit for future operation (except airflow direction).

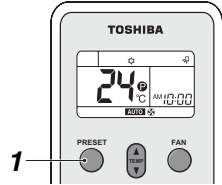

Select your preferred operation.

- 1 Press the PRESET button for 3 seconds to memorize the setting. The mark is displayed.

When you press this button next time, the memorized operation mode will be enabled.

■ Comfort sleep operation

COMFORT SLEEP mode is a OFF timer operation with automatic temperature and fan speed adjustment.

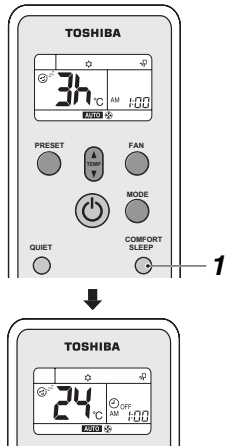

- 1 Press the COMFORT SLEEP button. Select 1, 3, 5 or 9 hours for the OFF timer operation.

⚠ CAUTION

The COMFORT SLEEP mode is not enabled in the DRY or FAN ONLY operation.

NOTE

- For the cooling operation, the set temperature will automatically increase 1 degree/hour for 2 hours (maximum 2 degrees increase). For the heating operation, the set temperature will decrease.
- During group control operation, the set temperature and the fan speed are not automatically adjusted. Only off timer function is activated.

■ Sleep timer operation

To start the sleep timer (OFF timer) operation.

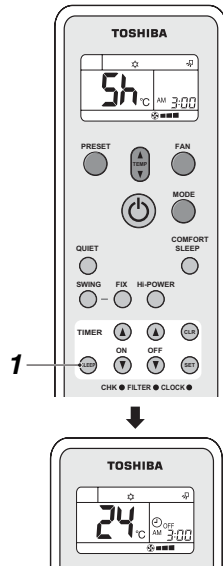

- 1 Press the SLEEP button. Select 1, 3, 5 or 9 hours for the OFF timer operation.

■ Adjusting airflow direction

- Adjust the airflow direction properly. Otherwise, it might cause discomfort and make the room temperature uneven.
- Adjust the vertical airflow using the remote controller.
- Adjust the horizontal airflow manually.

Adjust the vertical airflow

The air conditioner automatically adjusts the vertical airflow direction in accordance with the operating conditions when AUTO or A mode is selected.

To set the airflow direction you desire
Perform this function when the air conditioner is in operation.

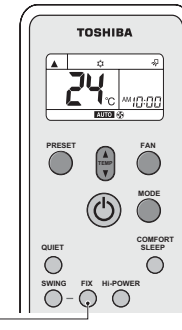
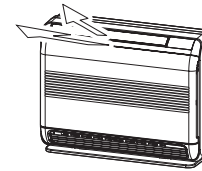

- 1 FIX button
Keep pressing or pressing briefly the FIX button on the remote controller to move the louver in the desired direction.
 - In subsequent operations, the vertical airflow is automatically set in the direction to which you adjusted the louver using the FIX button.

NOTE

- Operating angle of vertical airflow louver will be different during cooling, dry and heating operation.
- Concerning airflow from the lower air outlet grille. In the cooling operation, airflow is blown out only from the upper air outlet grille under some operating conditions. In the dry operation, airflow is blown out only from the upper air outlet grille.

To automatically swing the airflow direction

Perform this function when the air conditioner is in operation.

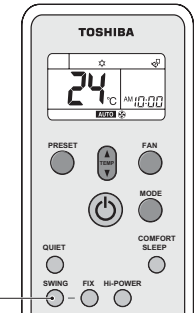
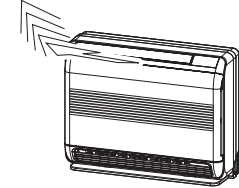

- 1 SWING button
Press the SWING button on the remote controller.
 - To stop the function, press the SWING button.

⚠ CAUTION

- The FIX and SWING buttons will be disabled when the air conditioner is not in operation (including when the ON timer is set).
- Do not operate the air conditioner for long hours with the airflow direction set downward during the cooling or dry operation. Otherwise, condensation may occur on the surface of the vertical airflow louver and cause dew dripping.
- Do not move the vertical airflow louver manually. Always use the FIX button. If you move the louver manually, it may malfunction during operation. If the louver malfunctions, stop the air conditioner once, and restart.
- When the air conditioner is started immediately after it was stopped, the vertical airflow louver might not move for 10 seconds or so.
- Louver operation is limited when performing group control. (see page 12)

■ Adjust the horizontal airflow

Preparation

- Take hold of the lever on the horizontal airflow louver and move them to adjust the airflow direction as required.
- You can adjust the airflow at the left, and right locations of the louver.

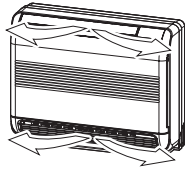

9 HINTS FOR ECONOMICAL OPERATION

■ Maintain room temperature at comfortable level

Clean air filters

The clogged air filters impairs the performance of the air conditioner. Clean them once two weeks.

Never open doors and windows more often than necessary

To keep cool or warm air in the room, never open doors and windows more often than necessary.

Window curtains

In cooling, close the curtains to avoid direct sunlight. In heating, close the curtains to keep the heat in.

Use the timer effectively

Set the timer for the desired operating time.

Get uniform circulation of room air

Adjust airflow direction for even circulation of room air.

10 TEMPORARY OPERATION

■ TEMPORARY operation

This function is used to operate the unit temporarily in case you misplace the wireless remote controller or its batteries are exhausted.

- Push the  button once (less than 3 seconds) to start the air conditioner.
- The last operation conducted with the wireless remote controller will be performed. (When wireless remote controller is not used, models with the auto-changeover (cooling/heating) function perform "A" operation, and those without the function perform cooling operation (set temperature: 24 °C, fan: HIGH).)

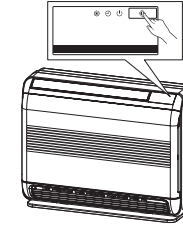

CAUTION

Continuous pressing of the  button for 10 seconds and above will start the forced cooling operation. (This will impose burden on the air conditioner. Do not perform this for the purposes other than test run.) In this time all indicators of indoor unit go on.

11 MAINTENANCE

WARNING

Before you clean the air conditioner, be sure to turn off the circuit breaker or main power switch. When cleaning the air filter and the air inlet grille, do not remove them at the same time. You may touch the aluminum fin of the unit and result in injury.

■ Cleaning of indoor unit and remote controller

CAUTION

- Use a dry cloth to wipe the indoor unit and remote controller.
- A cloth dampened with cold water may be used on the indoor unit if it is very dirty.
- Never use a damp cloth on the remote controller.
- Do not use a chemically-treated duster for wiping or leave such materials on the unit for long. It may damage or fade the surface of the unit.
- Do not use benzine, thinner, polishing powder, or similar solvents for cleaning. These may cause the plastic surface to crack or deform.

If you will not use the unit for at least 1 month

1. Operate the air conditioner in FAN ONLY mode for about half a day to dry the inside of the unit.
2. Stop the air conditioner and turn off the main power switch.
3. Remove the batteries from the remote controller.

Check before operation

CAUTION

- Check that the air filters are installed.
- Check that the air outlet or inlet of the outdoor unit is not blocked.

■ Cleaning the air filter

Clean the air filters every 2 weeks.
If the air filters are covered with dust, the performance of the air conditioner will deteriorate.

Clean the air filters as often as possible.

1. Open the air inlet grille by gripe at the handle then pull the air inlet grille as the arrow direction.

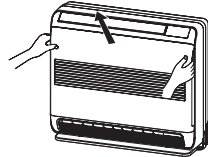

2. Take hold the left and right handles of air filter and push it down to release them from holding slot, then pull it upward to take it out.

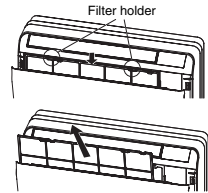

3. Use a vacuum cleaner to remove the dust from the filter or wash them with water. If you wash the air filter, dry them in the shade.



4. Insert the lower ribs of air filter into the slots then set it into the holding slot. (reverse the procedure number 2)

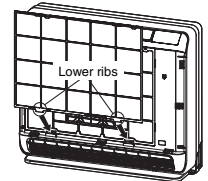

5. Close the air inlet grille.

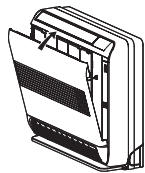

■ Cleaning the air inlet grille

1. Remove the air inlet grille by release the rope from the hook.

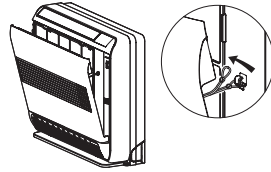

2. Wash it with water using a soft sponge or towel. (Do not use metallic scrubbing brush or the other hard brushed)
 - Use of such hard objects will cause scratches on the surface of air inlet grille.
 - If very dirty, clean the air inlet grille with a neutral detergent for kitchen use, and rinse it off with water.

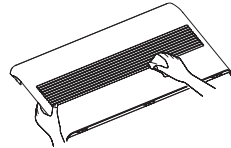

3. Wipe out water from air inlet grille and dry it.

4. Insert the lower hooks of air inlet grille into the slots.

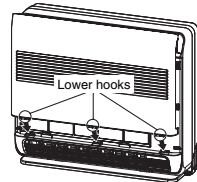

5. Hang the rope at the back side hook then close the air inlet grille.

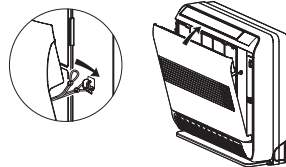

12 SPECIFICATIONS

Model	Sound power level (dBA)		Weight (kg)
	Cooling	Heating	
MML-AP0074NH-E	*	*	17
MML-AP0074NH-TR	*	*	17
MML-AP0094NH-E	*	*	17
MML-AP0094NH-TR	*	*	17
MML-AP0124NH-E	*	*	17
MML-AP0124NH-TR	*	*	17
MML-AP0154NH-E	*	*	17
MML-AP0154NH-TR	*	*	17
MML-AP0184NH-E	*	*	17
MML-AP0184NH-TR	*	*	17

* Under 70 dBA

Declaration of Conformity

Manufacturer: TOSHIBA CARRIER (THAILAND) CO., LTD.
144/9 Moo 5, Bangkadi Industrial Park, Tivanon Road,
Amphur Muang, Pathumthani 12000, Thailand

Authorized Representative/
TCF holder: Nick Ball
Toshiba EMEA Engineering Director
TOSHIBA CARRIER UK LTD.
Porsham Close, Belliver Industrial Estate,
PLYMOUTH, Devon, PL6 7DB.
United Kingdom

Hereby declares that the machinery described below:

Generic Denomination: Air Conditioner

Model/type: Indoor unit

MML-AP0074NH-E, MML-AP0094NH-E, MML-AP0124NH-E, MML-AP0154NH-E,
MML-AP0184NH-E, MML-AP0074NH-TR, MML-AP0094NH-TR, MML-AP0124NH-TR,
MML-AP0154NH-TR, MML-AP0184NH-TR

Commercial name: Super Modular Multi System Air Conditioner
Super Heat Recovery Multi System Air Conditioner
Mini-Super Modular Multi System Air Conditioner (MINI-SMMS series)

Complies with the provisions of the "Machinery" Directive (Directive 2006/42/EC) and the regulations transposing into national law

Complies with the provisions of the following harmonized standard:
EN 378-2: 2008+A1:2009

NOTE

This declaration becomes invalid if technical or operational modifications are introduced without the manufacturer's consent.

12. Installation Manual

Original instructions

- Please read this Installation Manual carefully before installing the Air Conditioner.
- This Manual describes the installation method of the indoor unit.
 - For installation of the outdoor unit, follow the Installation Manual attached to the outdoor unit.

ADOPTION OF NEW REFRIGERANT

This Air Conditioner is a new type which adopts a new refrigerant HFC (R410A) instead of the conventional refrigerant R22 in order to prevent destruction of the ozone layer.

Contents

1	PRECAUTIONS FOR SAFETY	4
2	ACCESSORY PARTS	6
3	SELECTION OF INSTALLATION PLACE	7
4	INSTALLATION OF INDOOR UNIT	9
5	CUTTING A HOLE AND MOUNTING INSTALLATION PLATE	10
6	PIPING AND DRAIN HOSE INSTALLATION	11
7	REFRIGERANT PIPING	13
8	ELECTRIC WORK	14
9	APPLICABLE CONTROLS	20
10	TEST RUN	22
11	TROUBLE SHOOTING	24

Thank you for purchasing this Toshiba air conditioner.

This Installation Manual describes the methods used to carry out the installation for the indoor unit.

For the installation of the outdoor unit, carry out the work by following the instructions in the Installation Manual provided with the outdoor unit.

This Installation Manual contains important information that complies with the "Machinery Directive" (Directive 2006/42/EC) so read through it carefully to ensure that you understand its contents.

After completing the installation work, hand over this Installation Manual as well as the Owner's Manual provided with the outdoor unit to the user, and ask the user to keep them in a safe place for future reference.

Provide a dedicated power outlet, which is separate from the one used for the outdoor unit, for supplying the power to the indoor unit.

Also, the Y-shape branching joint or branch header sold separately is required for the piping connections between the indoor unit and outdoor unit.

Select these joints or headers according to the piping system capacity.

Generic denomination : Air conditioner

Definition of qualified installer or qualified service person

The air conditioner must be installed, maintained, repaired and removed by a qualified installer or qualified service person. When any of these jobs is to be done, ask a qualified installer or qualified service person to do them for you. A qualified installer or qualified service person is an agent who has the qualifications and knowledge described in the table below.

Agent	Qualifications and knowledge which the agent must have
Qualified installer	<ul style="list-style-type: none"> • The qualified installer is a person who installs, maintains, relocates and removes the air conditioners made by Toshiba Carrier Corporation. He or she has been trained to install, maintain, relocate and remove the air conditioners made by Toshiba Carrier Corporation or, alternatively, he or she has been instructed in such operations by an individual or individuals who have been trained and is thus thoroughly acquainted with the knowledge related to these operations. • The qualified installer who is allowed to do the electrical work involved in installation, relocation and removal has the qualifications pertaining to this electrical work as stipulated by the local laws and regulations, and he or she is a person who has been trained in matters relating to electrical work on the air conditioners made by Toshiba Carrier Corporation or, alternatively, he or she has been instructed in such matters by an individual or individuals who have been trained and is thus thoroughly acquainted with the knowledge related to this work. • The qualified installer who is allowed to do the refrigerant handling and piping work involved in installation, relocation and removal has the qualifications pertaining to this refrigerant handling and piping work as stipulated by the local laws and regulations, and he or she is a person who has been trained in matters relating to refrigerant handling and piping work on the air conditioners made by Toshiba Carrier Corporation or, alternatively, he or she has been instructed in such matters by an individual or individuals who have been trained and is thus thoroughly acquainted with the knowledge related to this work. • The qualified installer who is allowed to work at heights has been trained in matters relating to working at heights with the air conditioners made by Toshiba Carrier Corporation or, alternatively, he or she has been instructed in such matters by an individual or individuals who have been trained and is thus thoroughly acquainted with the knowledge related to this work.
Qualified service person	<ul style="list-style-type: none"> • The qualified service person is a person who installs, repairs, maintains, relocates and removes the air conditioners made by Toshiba Carrier Corporation. He or she has been trained to install, repair, maintain, relocate and remove the air conditioners made by Toshiba Carrier Corporation or, alternatively, he or she has been instructed in such operations by an individual or individuals who have been trained and is thus thoroughly acquainted with the knowledge related to these operations. • The qualified service person who is allowed to do the electrical work involved in installation, repair, relocation and removal has the qualifications pertaining to this electrical work as stipulated by the local laws and regulations, and he or she is a person who has been trained in matters relating to electrical work on the air conditioners made by Toshiba Carrier Corporation or, alternatively, he or she has been instructed in such matters by an individual or individuals who have been trained and is thus thoroughly acquainted with the knowledge related to this work. • The qualified service person who is allowed to do the refrigerant handling and piping work involved in installation, repair, relocation and removal has the qualifications pertaining to this refrigerant handling and piping work as stipulated by the local laws and regulations, and he or she is a person who has been trained in matters relating to refrigerant handling and piping work on the air conditioners made by Toshiba Carrier Corporation or, alternatively, he or she has been instructed in such matters by an individual or individuals who have been trained and is thus thoroughly acquainted with the knowledge related to this work. • The qualified service person who is allowed to work at heights has been trained in matters relating to working at heights with the air conditioners made by Toshiba Carrier Corporation or, alternatively, he or she has been instructed in such matters by an individual or individuals who have been trained and is thus thoroughly acquainted with the knowledge related to this work.

Definition of protective gear



When the air conditioner is to be transported, installed, maintained, repaired or removed, wear protective gloves and 'safety' work clothing.

In addition to such normal protective gear, wear the protective gear described below when undertaking the special work detailed in the table below.

Failure to wear the proper protective gear is dangerous because you will be more susceptible to injury, burns, electric shocks and other injuries.

Work undertaken	Protective gear worn
All types of work	Protective gloves 'Safety' working clothing
Electrical-related work	Gloves to provide protection for electricians and from heat Insulating shoes Clothing to provide protection from electric shock
Transportation of heavy objects	Shoes with additional protective toe cap
Repair of outdoor unit	Gloves to provide protection for electricians and from heat

Warning indications on the air conditioner unit

Warning indication	Description
 <p>WARNING ELECTRICAL SHOCK HAZARD Disconnect all remote electric power supplies before servicing.</p>	<p>WARNING</p> <p>ELECTRICAL SHOCK HAZARD Disconnect all remote electric power supplies before servicing.</p>
 <p>WARNING Moving parts. Do not operate unit with grille removed. Stop the unit before the servicing.</p>	<p>WARNING</p> <p>Moving parts. Do not operate unit with grille removed. Stop the unit before the servicing.</p>
 <p>CAUTION Do not touch the aluminum fins of the unit. Doing so may result in injury.</p>	<p>CAUTION</p> <p>Do not touch the aluminum fins of the unit. Doing so may result in injury.</p>

1 PRECAUTIONS FOR SAFETY

The manufacturer shall not assume any liability for the damage caused by not observing the description of this manual.



General

- Before starting to install the air conditioner, read carefully through the Installation Manual, and follow its instructions to install the air conditioner.
- Only a qualified installer(*1) or qualified service person(*1) is allowed to install the air conditioner. If the air conditioner is installed by an unqualified individual, a fire, electric shocks, injury, water leakage, noise and/or vibration may result.
- Do not use any refrigerant different from the one specified for complement or replacement. Otherwise, abnormally high pressure may be generated in the refrigeration cycle, which may result in a failure or explosion of the product or an injury to your body.
- Before opening the front panel of the indoor unit or service panel of the outdoor unit, set the circuit breaker to the OFF position. Failure to set the circuit breaker to the OFF position may result in electric shocks through contact with the interior parts. Only a qualified installer(*1) or qualified service person(*1) is allowed to remove the front panel of the indoor unit or service panel of the outdoor unit and do the work required.
- Before carrying out the installation, maintenance, repair or removal work, be sure to set the circuit breaker to the OFF position. Otherwise, electric shocks may result.
- Place a "Work in progress" sign near the circuit breaker while the installation, maintenance, repair or removal work is being carried out. There is a danger of electric shocks if the circuit breaker is set to ON by mistake.
- Wear protective gloves and safety work clothing during installation, servicing and removal.
- Do not touch the aluminum fin of the unit. You may injure yourself if you do so. If the fin must be touched for some reason, first put on protective gloves and safety work clothing, and then proceed.
- The refrigerant used by this air conditioner is the R410A.

Selection of installation location

- If you install the unit in a small room, take appropriate measures to prevent the refrigerant from exceeding the limit concentration even if it leaks. Consult the dealer from whom you purchased the air conditioner when you implement the measures. Accumulation of highly concentrated refrigerant may cause an oxygen deficiency accident.
- Do not install the air conditioner in a location that may be subject to a risk of exposure to a combustible gas. If a combustible gas leaks and becomes concentrated around the unit, a fire may occur.
- When transporting the air conditioner, wear shoes with additional protective toe caps.
- Do not place any combustion appliance in a place where it is directly exposed to the wind of air conditioner, otherwise it may cause imperfect combustion.

Installation

- Install the air conditioner at enough strong places to withstand the weight of the unit. If the strength is not enough, the unit may fall down resulting in injury.
- Follow the instructions in the Installation Manual to install the air conditioner. Failure to follow these instructions may cause the product to fall down or topple over or give rise to noise, vibration, water leakage, etc.

Refrigerant piping

- Install the refrigerant pipe securely during the installation work before operating the air conditioner. If the compressor is operated with the valve open and without refrigerant pipe, the compressor sucks air and the refrigeration cycles is over pressurized, which may cause an injury.
- Tighten the flare nut with a torque wrench in the specified manner. Excessive tighten of the flare nut may cause a crack in the flare nut after a long period, which may result in refrigerant leakage.
- After the installation or servicing work, confirm that refrigerant gas does not leak. If refrigerant gas leaks into the room and flows near a fire source, such as a cooking range, noxious gas may be generated.
- When the air conditioner has been installed or relocated, follow the instructions in the Installation Manual and purge the air completely so that no gases other than the refrigerant will be mixed in the refrigerating cycle. Failure to purge the air completely may cause the air conditioner to malfunction.
- Nitrogen gas must be used for the airtight test.
- If refrigerant gas has leaked during the installation work, ventilate the room immediately. If the leaked refrigerant gas comes in contact with fire, noxious gas may be generated.

Electrical wiring

- Only a qualified installer(*1) or qualified service person(*1) is allowed to carry out the electrical work of the air conditioner. Under no circumstances must this work be done by an unqualified individual since failure to carry out the work properly may result in electric shocks and/or electrical leaks.
- When connecting the electrical wires, repairing the electrical parts or undertaking other electrical jobs, wear gloves to provide protection for electricians and from heat, insulating shoes and clothing to provide protection from electric shocks. Failure to wear this protective gear may result in electric shocks.
- Use wiring that meets the specifications in the Installation Manual and the stipulations in the local regulations and laws. Use of wiring which does not meet the specifications may give rise to electric shocks, electrical leakage, smoking and/or a fire.
- Be sure to connect earth wire. (Grounding work)
Incomplete grounding causes an electric shock.
- Do not connect ground wires to gas pipes, water pipes, and lightning rods or ground wires for telephone wires.
- After completing the repair or relocation work, check that the ground wires are connected properly.
- Install a circuit breaker that meets the specifications in the installation manual and the stipulations in the local regulations and laws.
- Install the circuit breaker where it can be easily accessed by the agent.
- When installing the circuit breaker outdoors, install one which is designed to be used outdoors.
- Under no circumstances must the power cable be extended. Connection trouble in the places where the cable is extended may give rise to smoking and/or a fire.
- Electrical wiring work shall be conducted according to law and regulation in the community and Installation manual. Failure to do so may result in electrocution/short circuit.

Test run

- Before operating the air conditioner after having completed the work, check that the front panel of the indoor unit and service panel of the outdoor unit are closed, and set the circuit breaker to the ON position. You may receive an electric shock if the power is turned on without first conducting these checks.
- When you have noticed that some kind of trouble (such as when an error display has appeared, there is a smell of burning, abnormal sounds are heard, the air conditioner fails to cool or heat or water is leaking) has occurred in the air conditioner, do not touch the air conditioner yourself but set the circuit breaker to the OFF position, and contact a qualified service person. Take steps to ensure that the power will not be turned on (by marking "out of service" near the circuit breaker, for instance) until qualified service person arrives. Continuing to use the air conditioner in the trouble status may cause mechanical problems to escalate or result in electric shocks, etc.
- After the work has finished, be sure to use an insulation tester set (500V Megger) to check the resistance is 1 MΩ or more between the charge section and the non-charge metal section (Earth section). If the resistance value is low, a disaster such as a leak or electric shock is caused at user's side.
- Upon completion of the installation work, check for refrigerant leaks and check the insulation resistance and water drainage. Then conduct a test run to check that the air conditioner is operating properly.

Explanations given to user

- Upon completion of the installation work, tell the user where the circuit breaker is located. If the user does not know where the circuit breaker is, he or she will not be able to turn it off in the event that trouble has occurred in the air conditioner.
- After the installation work, follow the Owner's Manual to explain to the customer how to use and maintain the unit.

Relocation

- Only a qualified installer(*1) or qualified service person(*1) is allowed to relocate the air conditioner. It is dangerous for the air conditioner to be relocated by an unqualified individual since a fire, electric shocks, injury, water leakage, noise and/or vibration may result.

(*1) Refer to the "Definition of qualified Installer or qualified service person."



CAUTION

New refrigerant air conditioner installation

- **THIS AIR CONDITIONER ADOPTS THE NEW HFC REFRIGERANT (R410A) WHICH DOES NOT DESTROY OZONE LAYER.**
- The characteristics of R410A refrigerant are; easy to absorb water, oxidizing membrane or oil, and its pressure is approx. 1.6 times higher than that of refrigerant R22. Accompanied with the new refrigerant, refrigerating oil has also been changed. Therefore, during installation work, be sure that water, dust, former refrigerant, or refrigerating oil does not enter the refrigerating cycle.
- To prevent charging an incorrect refrigerant and refrigerating oil, the sizes of connecting sections of charging port of the main unit and installation tools are changed from those for the conventional refrigerant.
- Accordingly the exclusive tools are required for the new refrigerant (R410A).
- For connecting pipes, use new and clean piping designed for R410A, and please care so that water or dust does not enter.

To disconnect the appliance from main power supply.

- This appliance must be connected to the main power supply by means of a switch with a contact separation of at least 3 mm.
- **The installation fuse must be used for the power supply line of this conditioner.**
- **Tighten the flare nut with a torque wrench in the specified manner.**
Excessive tightening of the flare nut may cause a crack in the flare nut after a long period, which may result in refrigerant leakage.
- **Wear heavy gloves and a long sleeve shirt during the installation work to avoid injury.**

2 ACCESSORY PARTS

■ Accessory parts

Part name	Q'ty	Shape
Installation plate	1	
Wireless remote controller	1	
Battery	2	
Remote control holder	1	
Mounting screw Ø4 x 25 ℓ	8	
Pan head wood screw Ø3.1 x 16 ℓ	2	
Heat insulator	1	
Banding band (for anchoring the insulated pipes)	2	
Banding band (for banding control and remote controller wire)	1	

<Others>

Name
Owner's manual
Installation manual

3 SELECTION OF INSTALLATION PLACE

⚠ WARNING

- Install the air conditioner at enough strong place to withstand the weight of the unit.
If the strength is not enough, the unit may fall down resulting in injury.

⚠ CAUTION

- Do not install the air conditioner in a location subject to a risk of exposure to a combustible gas.
If a combustible gas leaks and stays around the unit, a fire may occur.

Upon approval of the customer, install the air conditioner in a place that satisfies the following conditions.

- Place where the unit can be installed horizontally.
- Place where a sufficient servicing space can be ensured for safety maintenance and check.
- Place where drained water will not cause any problem.

Avoid installing in the following places.

- Place exposed to air with high salt content (seaside area), or place exposed to large quantities of sulfide gas (hot spring).
(Should the unit be used in these places, special protective measures are needed.)
- A restaurant kitchen where a lot of oil is used or place near machines in a factory (Oil adhering to the heat exchanger and resin part (cross flow fan) in the indoor unit may reduce the performance, generate mist or dew drop, or deform or damage resin parts.)
- Place where organic solvent is used nearby.
- Place close to a machine generating high frequency.
- Place where the discharged air blows directly into the window of the neighbour house. (Outdoor unit)
- Place where noise of the outdoor unit is easily transmitted.
(When install the outdoor unit on the boundary with the neighbour, pay due attention to the level of noise.)
- Place with poor ventilation.
- Do not use the air conditioner for special purposes such as preserving food, precision instruments, or art objects, or where breeding animals or growing plants are kept. (This may degrade the quality of preserved materials.)
- Place where any of high-frequency appliances (including inverter devices, private power generators, medical equipment, and communication equipment) and inverter-type fluorescent light is installed.
(A malfunction of the air conditioner, abnormal control, or problems due to noise to such appliances/equipment may occur.)
- When the wireless remote controller is used in a room equipped with an inverter-type fluorescent light or at a place exposed to direct sunlight, signals from the remote controller may not be received correctly.
- Place where organic solvent is used.
- Place near a door or window exposed to humid outside air (Dew dropping may form.).
- Place where special spray is used frequently.

■ Installation diagram of indoor and outdoor units

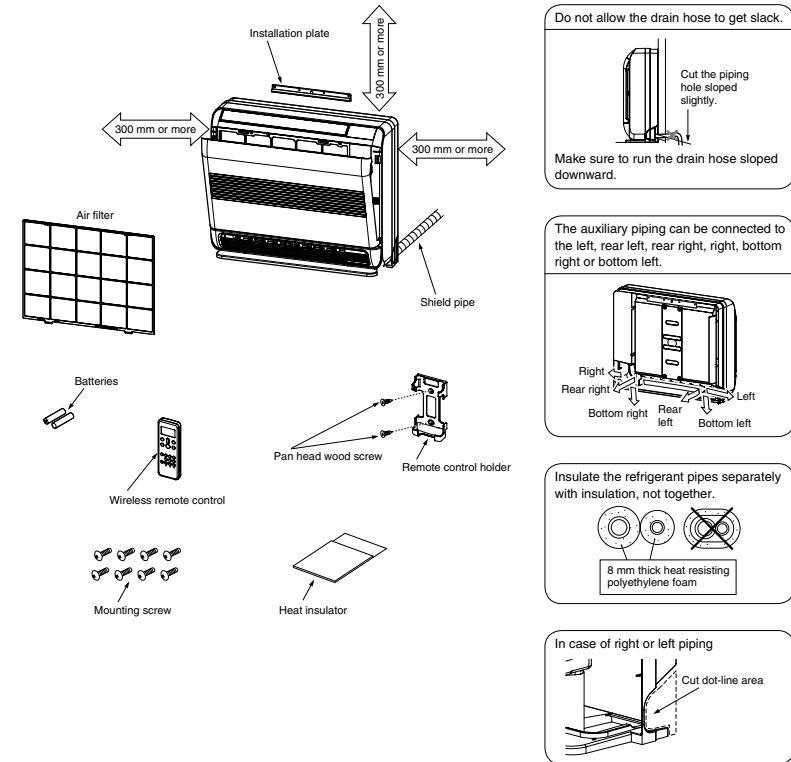

■ Installation place

- A place which provides the spaces around the indoor unit as shown in the diagram.
- A place where there are no obstacles near the air inlet and outlet.
- A place which allows easy installation of the piping to the outdoor unit.
- A place which allows the front panel to be opened.

⚠ CAUTION

- Direct sunlight to the indoor unit's wireless receiver should be avoided.
- The microprocessor in the indoor unit should not be too close to RF noise sources.
(For details, see the owner's manual.)

Remote control

- A place where there are no obstacles such as a curtain that may block the signal from the remote control.
- Do not install the remote control in a place exposed to direct sunlight or close to a heating source such as a stove.
- Keep the remote control at least 1 m apart from the nearest TV set or stereo equipment (This is necessary to prevent image disturbances or noise interference).
- The location of the remote control should be determined as shown below.

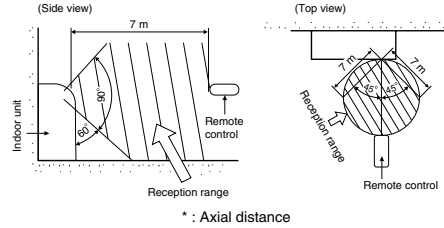

4 INSTALLATION OF INDOOR UNIT

WARNING

Install the air conditioner certainly to sufficiently withstand the weight.
If the strength is insufficient, the unit may fall down resulting in human injury.
Perform a specified installation work to guard against strong wind or earthquake.
An incomplete installation can cause accidents by the units falling and dropping.

REQUIREMENT

- Strictly comply with the following rules to prevent damage of the indoor units and human injury.
- Do not put a heavy article on the indoor unit. (Even units are packaged)
 - Carry in the indoor unit as it is packaged if possible. If carrying in the indoor unit unpacked by necessity, be sure to use buffering cloth, etc. to not damage the unit.
 - To move the indoor unit, do not apply force to the refrigerant pipe, drain pan, foamed parts, or resin parts, etc.
 - Carry the package by two or more persons, and do not bundle it with plastic band at positions other than specified.

Be careful to the following items when installing the unit.

- Considering air discharge direction, select an installation place where discharge air can circulate evenly in a room.
Avoid to install the unit at place with "NO GOOD" mark in the right figure.

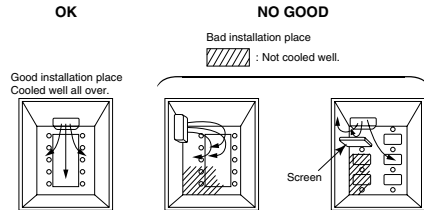

5 CUTTING A HOLE AND MOUNTING INSTALLATION PLATE

Cutting a hole

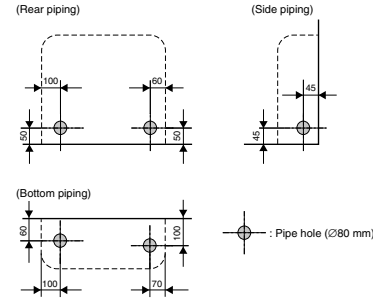

1. After determining the pipe hole position, drill the pipe hole (280 mm) at a slight downward slant to the outdoor side.

NOTE

- When drilling a wall that contains a metal lath, wire lath or metal plate, be sure to use a pipe hole brim ring sold separately.

Mounting the installation plate and screw position

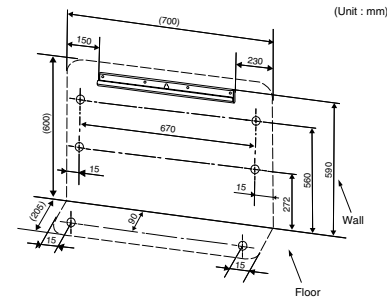

CAUTION

When installing the installation plate with a mounting screw, do not use the anchor bolt hole. Otherwise the unit may fall down and result in personal injury and property damage.

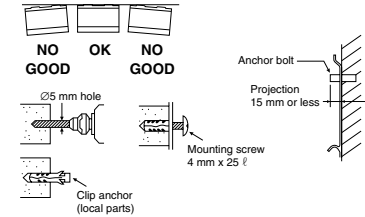

CAUTION

Failure to firmly install the unit may result in personal injury and property damage if the unit falls.

- In case of block, brick, concrete or similar type walls, make 25 mm holes in the wall.
- Insert clip anchors for appropriate mounting screws.

NOTE

- Secure four corners and lower parts of the installation plate with 6 mounting screws to install it.

6 PIPING AND DRAIN HOSE INSTALLATION

How to install indoor unit

1. Remove the air inlet grille. Open the air inlet grille and remove the strap.
2. Remove the front panel (Remove the 4 screws).

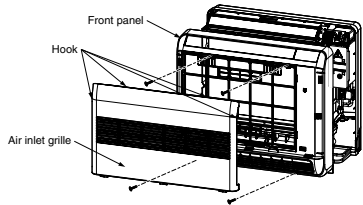

Layout of connection piping

NOTE

When bending the connection piping, make sure to use a pipe bender so as not to crush the pipe.

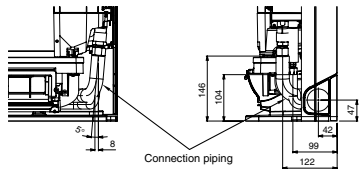
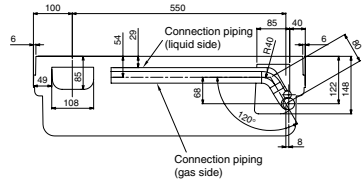

In case of bottom right piping

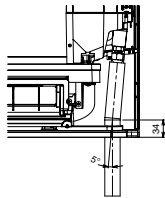

Drainage

1. Run the drain hose sloped downwards.

NOTE

- The hole should be made at a slight downward slant on the outdoor side.

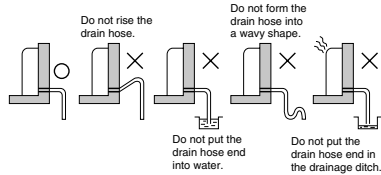

2. Put water in the drain pan and make sure that the water is drained out of doors.
3. When connecting extension drain hose, insulate the connecting part of extension drain hose with shield pipe.

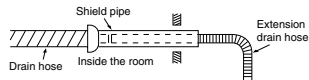

CAUTION

Arrange the drain pipe for proper drainage from the unit. Improper drainage can result in dew-dropping.

How to use the heat insulation block

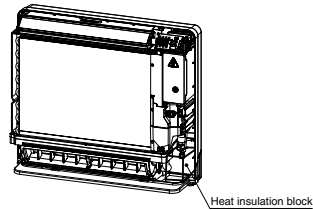

- Completely fill pipe hole by heat insulation block to protect water dew.
- Heat insulation block can cut to an appropriate size and use.

Mounting directly on the floor

- 1) Fix the leg of indoor unit on the floor with 2 mounting screws.
- 2) Fix the upper part of indoor unit on the wall with 4 mounting screws.

(Floor installation)

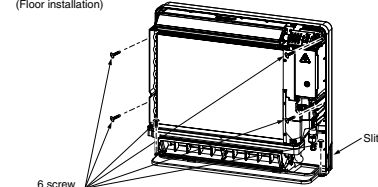

NOTE

- In case the plinth is fixed to the wall, please make sure to cut out the slit on the left and right side of the main part.

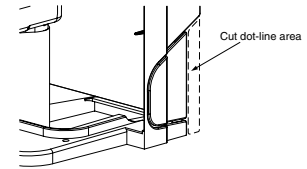

Installation on the wall

- 1) Fix the installation plate on the wall with 4 mounting screws.
- 2) Hook the indoor unit on the installation plate.
- 3) Fix the upper part of indoor unit on the wall with 4 mounting screws.

(Wall installation)

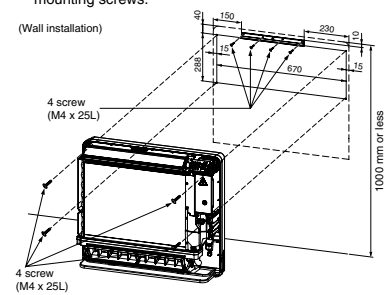

CAUTION

Make sure to fix it at a designated position with the screws. Failure may result in the damage of piping by the turning over of a set.

Concealed installation

1. Wall hole size

Wall hole size should be enough to keep the distance with indoor unit as shown in the following figure.

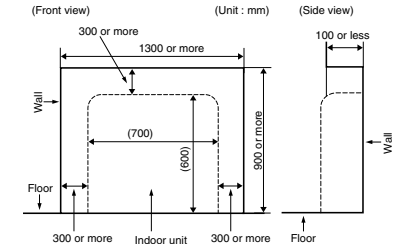

2. Installation using the supporting plate

- To install into the existing wall hole, if it is impossible to keep 20-30 mm of depth, use the supporting plate for securing the distance.
- Arrange the screw positions and supporting plate as shown in the figure.
- Be sure to switch to wall burying mode.

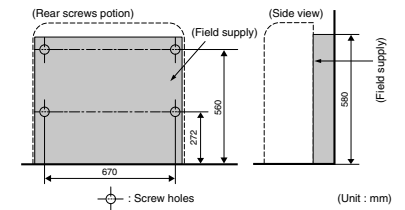

7 REFRIGERANT PIPING

■ Refrigerant piping

1. Use copper pipe with 0.8 mm or more thickness.
2. Flare nut and flare works are also different from those of the conventional refrigerant.
Take out the flare nut attached to the main unit of the air conditioner, and use it.

REQUIREMENT

When the refrigerant pipe is long, provide support brackets at intervals of 2.5 to 3 m to clamp the refrigerant pipe. Otherwise, abnormal sound may be generated.

CAUTION

IMPORTANT 4 POINTS FOR PIPING WORK

1. Remove dust and moisture from the inside of the connecting pipes.
2. Tight connection (between pipes and unit)
3. Evacuate the air in the connecting pipes using VACUUM PUMP.
4. Check the gas leakage. (Connected points).

■ Pipe size

(dia : mm)

MML-	AP007 to AP012 type	AP015 to AP018 type
Gas side	9.5	12.7
Liquid side	6.4	6.4

■ Permissible piping length and height difference

They vary according to the outdoor unit.
For details, refer to the Installation Manual attached to the outdoor unit.

Flaring

- Cut the pipe with a pipe cutter.
Remove burrs completely.
Remaining burrs may cause gas leakage.
- Insert a flare nut into the pipe, and flare the pipe.
As the flaring sizes of R410A differ from those of refrigerant R22, the flare tools newly manufactured for R410A are recommended.
However, the conventional tools can be used by adjusting projection margin of the copper pipe.

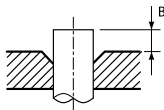

▼ Projection margin in flaring: B (Unit: mm)

Rigid (Clutch type)

Outer dia. of copper pipe	R410A tool used	Conventional tool used
	R410A	R410A
6.4, 9.5	0 to 0.5	1.0 to 1.5
12.7		

▼ Flaring dia. meter size: A (Unit: mm)

Outer dia. of copper pipe	A _註
	R410A
6.4	9.1
9.5	13.2
12.7	16.6

- * In case of flaring for R410A with the conventional flare tool, pull it out approx. 0.5 mm more than that for R22 to adjust to the specified flare size. The copper pipe gauge is useful for adjusting projection margin size.

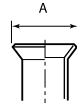

Tightening connection

CAUTION

- Do not apply excessive torque. Otherwise, the nut may crack depending on the conditions.

(Unit: N·m)

Outer dia. of copper pipe	Tightening torque
6.4 mm (dia.)	14 to 18 (1.4 to 1.8 kgf·m)
9.5 mm (dia.)	33 to 42 (3.3 to 4.2 kgf·m)
12.7 mm (dia.)	50 to 62 (5.0 to 6.2 kgf·m)

▼ Tightening torque of flare pipe connections

Pressure of R410A is higher than that of R22. (Approx. 1.6 times) Therefore, using a torque wrench, tighten the flare pipe connecting sections which connect the indoor and outdoor units of the specified tightening torque.
Incorrect connections may cause not only a gas leak, but also a trouble of the refrigeration cycle.
Align the centres of the connecting pipes and tighten the flare nut as far as possible with your fingers. Then tighten the nut with a spanner and torque wrench as shown in the figure.

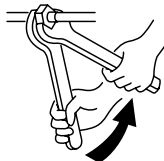

Work using double spanner

REQUIREMENT

Tightening with an excessive torque may crack the nut depending on installation conditions.
Tighten the nut within the specified tightening torque.

Piping with outdoor unit

- Shape of valve differs according to the outdoor unit.
For details of installation, refer to the Installation Manual of the outdoor unit.

■ Airtight test/Air purge, etc.

For airtight test, air purge, addition of refrigerant, and gas leak check, follow the Installation Manual attached to the outdoor unit.

REQUIREMENT

Use a leak detector manufactured exclusively HFC refrigerant (R410A, R134a, etc.).

■ Open fully valves of the outdoor unit

Heat insulation

Heat insulation for the pipes should be done separately for the liquid side and gas side. Because both of the liquid and gas side pipes become a low temperature during cooling operation, sufficient heat insulation should be done to prevent condensation.

- Heat insulator with a heat resistance of 120°C or more must be used for the gas side pipe.
- The pipe connection section of the indoor unit must be heat insulated securely and compactly with the attached heat insulator.

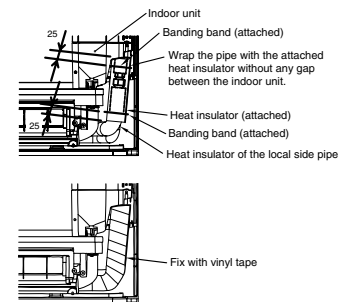

8 ELECTRIC WORK

WARNING

1. Using the specified wires, ensure to connect the wires, and fix wires securely so that the external tension to the wires do not affect the connecting part of the terminals.
Incomplete connection or fixation may cause a fire, etc.
2. Be sure to connect earth wire. (grounding work)
Incomplete grounding cause an electric shock.
Do not connect ground wires to gas pipes, water pipes, lightning rods or ground wires for telephone wires.
3. Appliance shall be installed in accordance with national wiring regulations.
Capacity shortage of power circuit or incomplete installation may cause an electric shock or a fire.

CAUTION

- If incorrect/incomplete wiring is carried out, it will cause an electrical fire or smoke.
- Be sure to install an earth leakage breaker that is not tripped by shock waves.
If an earth leakage breaker is not installed, an electric shock may be caused.
- Be sure to use the cord clamps attached to the product.
- Do not damage or scratch the conductive core and inner insulator of power and interconnecting wires when peeling them.
- Use the power cord and Inter-connecting wire of specified thickness, type, and protective devices required.
- Never connect 220–240V power to the terminal blocks (U), (V), (A), (B), etc.) for control wiring. (Otherwise, the system will fail.)

REQUIREMENT

- For power supply wiring, strictly conform to the Local Regulation in each country.
- For wiring of power supply of the outdoor units, follow the Installation Manual of each outdoor unit.
- Perform the electric wiring so that it does not come to contact with the high-temperature part of the pipe. The coating may melt resulting in an accident.
- After connecting wires to the terminal blocks, provide a trap and fix wires with the cord clamp.
- Run the refrigerant piping line and control wiring line in the same line.
- Do not turn on the power of the indoor unit until vacuuming of the refrigerant pipes completes.

Power supply wire and communication wires specifications

Power supply wire and communication wires are procured locally. For the power supply specifications, follow the table below. Power supply wiring and communication wiring are to be procured locally. For specifications of the power capacity of the outdoor unit and the power supply wires, refer to the Installation Manual supplied with the outdoor unit.

Indoor unit power supply

- Prepare an exclusive power supply for the indoor unit independently of the outdoor unit.
- Arrange the power supplies to the indoor and outdoor units, so that a common earth leakage breaker and main switch can be used.
- Power supply wire specification: Cable 3-core 2.5 mm², in conformity with Design H07 RN-F or 60245 IEC 57.

Power supply

Power supply		220–240V ~ 50Hz 220V ~ 60Hz
Power supply switch/Earth leakage breaker or power supply wiring/fuse rating for indoor units should be selected by the accumulated total current values of the indoor units.		
Power supply wiring	Below 50 m	2.5 mm ²

Control wiring, Central controller wiring

- Use a 2 core non polarity wire.
- To prevent any possible noise issues, use a shielded 2 core wire.
- The total stated length of communication wiring is determined by the interconnecting length of indoor to outdoor wire plus the length of the central control communication wire.

Communication line

Control wiring between indoor units, and outdoor unit (2-core shield wire)	Wire size	(Up to 1000 m) 1.25 mm ² (Up to 2000 m) 2.0 mm ²
Central control line wiring (2-core shield wire)	Wire size	(Up to 1000 m) 1.25 mm ² (Up to 2000 m) 2.0 mm ²

Wired remote controller wiring

This wiring is not required when using the supplied wireless remote controller.

- For wiring remote controllers a 2 core non polarity wire must be used.

Wired remote controller wiring, remote controller inter-unit wiring	Wire size 0.5 mm ² to 2.0 mm ²	
Total wire length of wired remote controller wiring and remote controller inter-unit wiring = L + L1 + L2 + ... Ln	In case of wired type only	Up to 500 m
	In case of wireless type included	Up to 400 m
Total wire length of wired remote controller inter-unit wiring = L1 + L2 + ... Ln	Up to 200 m	

CAUTION

The remote controller wire (Communication line) and AC220–240V wires cannot be parallel to contact each other and cannot be stored in the same conduits. If doing so, a trouble may be caused on the control system due to noise, etc.

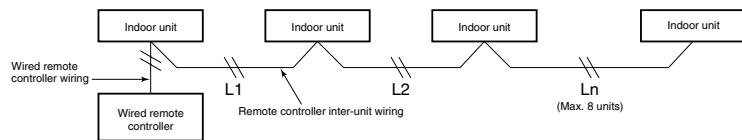

Control wiring between indoor and outdoor units

NOTE

An outdoor unit that is interconnected to the indoor units automatically becomes the header unit.

Wiring example

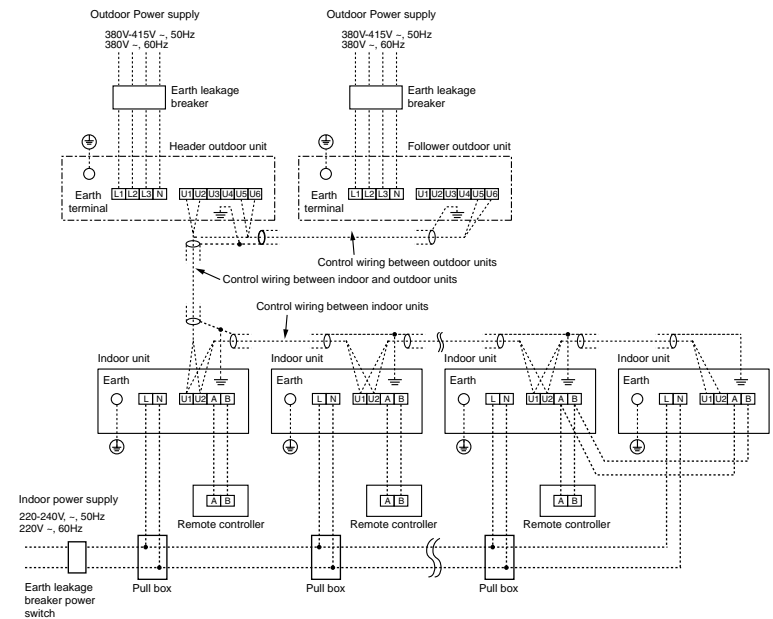

Wired remote controller wiring

- As the wired remote controller wire has non-polarity, there is no problem if connections to indoor unit terminal blocks A and B are reversed.

Wiring diagram

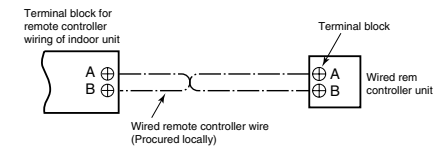

Address setup

Set up the addresses as per the Installation Manual supplied with the outdoor unit.

■ Wiring connection

How to connect the power supply wiring and control wiring

REQUIREMENT

Connect the control wire after connecting the power supply wire for this model.

1) How to connect the power supply wiring

1. Removing the front panel.
2. Remove the terminal cover and cord clamp.
3. Take a power supply wire and control wire (according to the local rule) into the pipe hole on the hole.
4. Take the power supply wire out of the cable slot on the rear panel so that it produces about 430 mm form the front.
5. Insert the power supply wire fully into the terminal block and secure it tightly with screws.
Tighten torque: 1.2 N/m (0.12 kgf/m)
6. Clamp the power supply wire with the cord clamp.
7. Attach the terminal cover with a screw

⚠ CAUTION

- Be sure to refer to the wiring diagram attached inside the front panel.
- Check local electrical cords and also any specific wiring instructions and limitations.
- Do not catch the control wire when installing the clamp base.

104

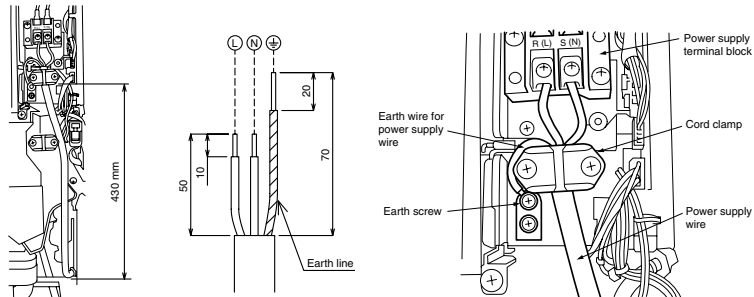
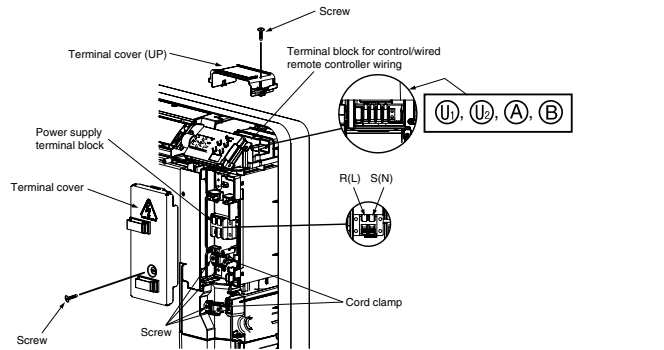

<Stripping length of the power supply wire>

<Connecting power supply wire>

2) How to connect the control wiring

1. Take the control wire out of the cable slot on the rear panel so that it produces about 600 mm form the front.
2. Remove the terminal cover (UP)
3. Remove the LED BASE
4. Insert the control wire fully into the control/Wired remote controller terminal block (U, U, A, B) and secure it tightly with screws.
5. Clamp the control wire with the cable clamp.
6. Pass the banding band through the hole of the mount base.
7. Band the control wire and the remote controller wire in the banding band.
8. Attach the LED base, terminal cover and front panel.

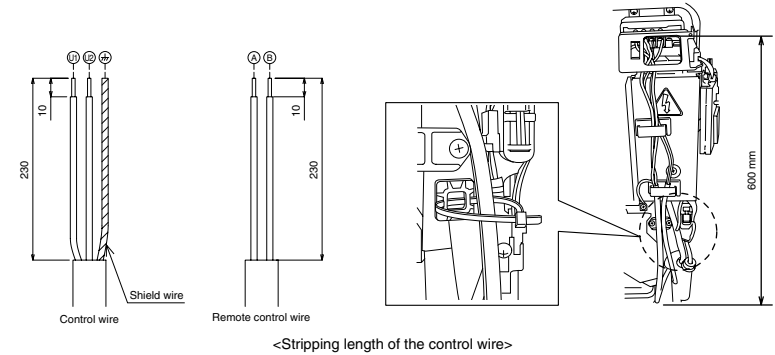

<Stripping length of the control wire>

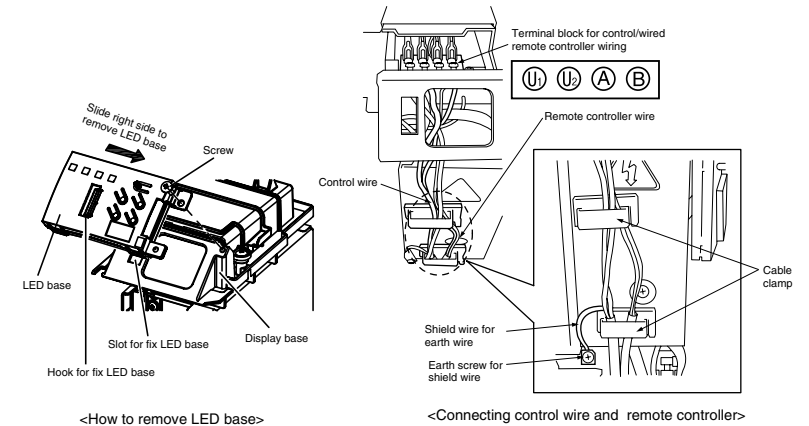

<How to remove LED base>

<Connecting control wire and remote controller>

■ Wiring connection for flow selector unit

How to connect the wiring of flow selector unit

Connect the power supply wire and the communication wire supplied with the flow selector unit to the indoor unit.

1. Removing the front panel.
2. Remove the terminal cover and cord clamp.
3. Take a power supply wire and control wire (according to the local rule) into the pipe hole on the hole.
4. Take the power supply wire out of the cable slot on the rear panel so that it produces about 430 mm from the front.
5. Insert the power supply wire fully into the terminal block and secure it tightly with screws.
Tighten torque: 1.2 N/m (0.12 kgf/m)
6. Insert the power supply wire faston terminal of the flow selector unit into the power supply terminal.
Secure the earth line with the earth screw.
7. Connect the control wire connector of flow selector unit to the control wire.
8. Clamp the power supply wire with the cord clamp.
9. Attach the terminal cover with a screw
10. Take the control wire out of the cable slot on the rear panel so that it produces about 600 mm from the front.
11. Remove the terminal cover (UP)
12. Remove the LED BASE
13. Insert the control wire fully into the control/Wired remote controller terminal block (U), (U), (A), (B) and secure it tightly with screws.
14. Clamp the control wire with the cord clamp.
15. Attach the LED base, terminal cover (UP) and front panel

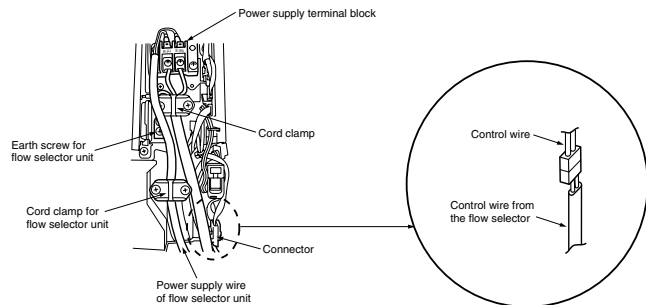

9 APPLICABLE CONTROLS

A wired remote controller is necessary for this function. This function cannot operate with a wireless remote controller.

REQUIREMENT

When using the air conditioner for the first time, it will take some moments after the power has been turned on before the remote controller becomes available for operations: This is normal and is not indicative of trouble.

- Concerning the automatic addresses (The automatic addresses are set up by performing operations on the outdoor interface circuit board.)
While the automatic addresses are being set up, no remote controller operations can be performed. Setup takes up to 10 minutes (usually about 5 minutes).
- When the power is turned on after automatic address setup
It takes up to 10 minutes (usually about 3 minutes) for the outdoor unit to start operating after the power has been turned on.
Before the air conditioner was shipped from the factory, all units are set to [STANDARD] (factory setting). If necessary, change the indoor unit settings. The settings are changed by operating the wired remote controller.
- The settings cannot be changed using only a wireless remote controller, simple remote controller or group control remote controller by itself so install a wired remote controller separately as well.

■ Changing of settings of for applicable controls

Basic procedure for changing settings

Change the settings while the air conditioner is not working.

(Be sure to stop the air conditioner before making settings.)

Requirement when setting the CODE No.

Set only the CODE No. shown in the following table: Do NOT set any other CODE No.

If a CODE No. not listed is set, it may not be possible to operate the air conditioner or other trouble with the product may result.

- The displays appearing during the setting process differ from the ones for previous remote controllers (AMT31E). (There are more CODE No.)

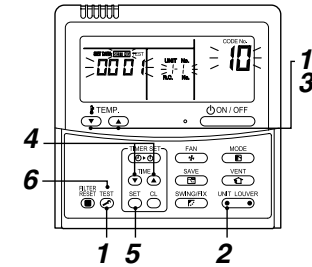

Procedure 1

Push button and "TEMP." button simultaneously for at least 4 seconds.

After a while, the display flashes as shown in the figure.

Confirm that the CODE No. is [10].

- If the CODE No. is not [10], push button to erase the display content, and repeat the procedure from the beginning.

(No operation of the remote controller is accepted for a while after button is pushed.)

(While air conditioners are operated under the group control, "ALL" is displayed first. When is pushed, the indoor unit number displayed following "ALL" is the header unit.)

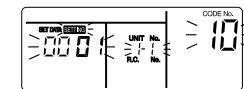

(* Display content varies with the indoor unit model.)

Procedure 2

Each time you push button, indoor unit numbers in the control group change cyclically.

Select the indoor unit you want to change settings for. The fan of the selected unit runs and the louvers start swinging. You can confirm the indoor unit for which you want to change settings.

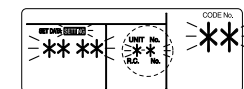

Procedure 3



Using "TEMP." (▼) / (▲) buttons, specify CODE No. [***].

Procedure 4

Using timer "TIME." (▼) / (▼) buttons, select SET DATA [****].

Procedure 5

Push  button. When the display changes from flashing to lit, the setup is completed.

- To change settings of another indoor unit, repeat from Procedure 2.
- To change other settings of the selected indoor unit, repeat from Procedure 3. Use  button to clear the settings. To make settings after  button was pushed, repeat from Procedure 2.

Procedure 6

When settings have been completed, push  button to determine the settings.

When  button is pushed, "SETTING" flashes and then the display content disappears and the air conditioner enters the normal stop mode.

(While "SETTING" is flashing, no operation of the remote controller is accepted.)

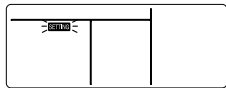

Change of lighting time of filter sign

According to the installation condition, the lighting time of the filter sign (Notification of filter cleaning) can be changed.

Follow to the basic operation procedure

(1 → 2 → 3 → 4 → 5 → 6).

- For the CODE No. in Procedure 3, specify [01].
- For the [SET DATA] in Procedure 4, select the SET DATA of filter sign lighting time from the following table.

SET DATA	Filter sign lighting time
0000	None
0001	150H (Factory setting)
0002	2500H
0003	5000H
0004	10000H

To secure better effect of heating

When it is difficult to obtain satisfactory heating due to installation place of the indoor unit or structure of the room, the detection temperature of heating can be raised. Also use a circulator, etc. to circulate heat air near the ceiling.

Follow to the basic operation procedure

(1 → 2 → 3 → 4 → 5 → 6).

- For the CODE No. in Procedure 3, specify [06].
- For the SET DATA in Procedure 4, select the SET DATA of shift value of detection temperature to be set up from the table below.

SET DATA	Detection temp shift value
0000	No shift
0001	+1°C
0002	+2°C
0003	+3°C (Factory setting)
0004	+4°C
0005	+5°C
0006	+6°C

Group control

In a group control, a remote controller can control up to maximum 8 units.

- The wired remote controller only can control a group control. The wireless remote controller is unavailable for this control.
- For cabling procedure and cables of the individual line (Identical refrigerant line) system, refer to "Electric work" in this Manual.
- Cabling between indoor units in a group is performed in the following procedure. Connect the indoor units by connecting the remote controller inter-unit cables from the remote controller terminal blocks (A, B) of the indoor unit connected with a remote controller to the remote controller terminal blocks (A, B) of the other indoor unit. (Non-polarity)
- For address setup, refer to the Installation Manual attached to the outdoor unit.

NOTE

Net work adapter (Model TCB-PCNT20E) can not connect to this air conditioner.

10 TEST RUN

A wired remote controller is necessary for this function. This function cannot be operate with a wireless remote controller.

Before test run

- Before turning on the power supply, carry out the following procedure.
 - Using 500V-megger, check that resistance of 1MΩ or more exists between the terminal block of the power supply and the earth (grounding). If resistance of less than 1MΩ is detected, do not run the unit.
 - Check the valve of the outdoor unit being opened fully.
- To protect the compressor at activation time, leave power-ON for 12 hours or more be for operating.

WARNING

- Never press the electromagnetic contactor to forcibly perform a test run. (This is very dangerous because the protective device does not work.)
- Before starting a test run, be sure to set addresses following the installation manual supplied with the outdoor unit.

How to execute a test run

Using the wired remote controller, operate the unit as usual.

For the procedure of the operation, refer to the attached Owner's Manual.

A forced test run can be executed in the following procedure even if the operation stops by thermo.-OFF. In order to prevent a serial operation, the forced test run is released after 60 minutes have passed and returns to the usual operation.

CAUTION

- Do not use the forced test run for cases other than the test run because it applies an excessive load to the devices.

In case of wired remote controller

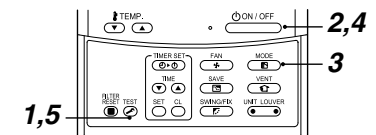

Procedure 1

Keep  button pushed for 4 seconds or more. [TEST] is displayed on the display part and the selection of mode in the test mode is permitted.

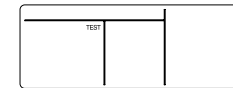

Procedure 2

Push  button.

Procedure 3

Using  button, select the operation mode, [COOL] or [HEAT].

- Do not run the air conditioner in a mode other than [COOL] or [HEAT].
- The temperature controlling function does not work during test run.
- The detection of error is performed as usual.

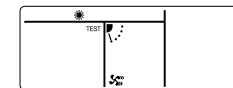

Procedure 4

After the test run, push  button to stop a test run.

(Display part is same as procedure 1.)

Procedure 5

Push  check button to cancel (release from) the test run mode.

([TEST] disappears on the display and the status returns to a normal.)

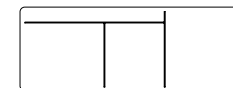



In case of wireless remote controller (Forced test operation is performed in a different way.)

REQUIREMENT

- For the operation procedure, be sure to follow the Owner's Manual.
- Finish the forced cooling operation in a short time because it applies excessive strength to the air conditioner.
- A test operation of forced heating is unavailable. Perform a test operation by heating operation using the switches of the remote controller.
However heating operation may be not carried out according to the temperature conditions.

• Check wiring/piping of indoor and outdoor units

1. When pushing  button for 10 seconds or more, "Pii" sound is heard and the operation changes to a forced cooling operation. After approx. 3 minutes, a cooling operation starts forcedly. Check cool air starts blowing. If the operation does not start, check wiring again.
2. To stop a test operation, push  button once again (Approx. 1 second). The louver closes and the operation stops.

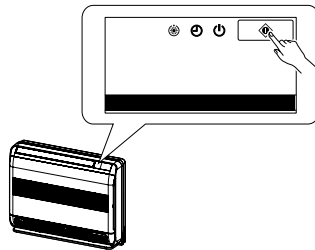

• Check transmission of remote controller

1. Push "START/STOP" button of the remote controller to check an operation can also start by the remote controller.
 - "Cooling" operation by the remote controller may be unavailable according to the temperature conditions. Check wiring/piping of the indoor and outdoor units in forced cooling operation.

11 TROUBLE SHOOTING

A wired remote controller is necessary for this function. This function cannot be operate with a wireless remote controller.

■ Confirmation and check

When a trouble occurred in the air conditioner, the check code and the indoor UNIT No. appear on the display part of the remote controller.

The check code is only displayed during the operation. If the display disappears, operate the air conditioner according to the following "Confirmation of error history" for confirmation.

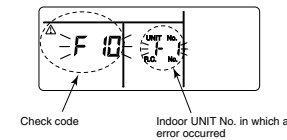



■ Confirmation of error history

When a trouble occurred on the air conditioner, the trouble history can be confirmed with the following procedure. (The trouble history is stored in memory up to 4 troubles.)

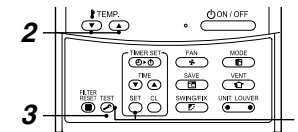
The history can be confirmed from both operating status and stop status.



Procedure 1

When pushing  and  buttons at the same time for 4 seconds or more, the following display appears.

If [Service check]  is displayed, the mode enters in the trouble history mode.

- [01: Order of trouble history] is displayed in CODE No. window.
- [Check code] is displayed in CHECK window.
- [Indoor unit address in which an error occurred] is displayed in UNIT No.

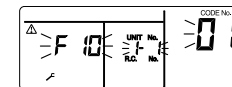

Procedure 2

Every pushing of "TEMP."  button used to set temperature, the trouble history stored in memory is displayed in order.

The numbers in CODE No. indicate CODE No. [01] (latest) → [04] (oldest).

REQUIREMENT

Do not push  button because all the trouble history of the indoor unit will be deleted.

Procedure 3

After confirmation, push  button to return to the usual display.

■ Check method

On the remote controller (Wired remote controller, Central control remote controller) and the interface P.C. board of the outdoor unit (I/F), a check display LCD (Remote controller) or 7-segment display (on the outdoor interface P.C. board) to display the operation is provided. Therefore the operation status can be known. Using this self-diagnosis function, a trouble or position with error of the air conditioner can be found as shown in the table below.

■ Check code list

The following list shows each check code. Find the check contents from the list according to part to be checked.

- In case of check from indoor remote controller: See "Wired remote controller display" in the list.
- In case of check from outdoor unit: See "Outdoor 7-segment display" in the list.
- In case of check from indoor unit with wireless remote controller: See "Sensor block display of receiving unit" in the list.

AI-NET: Artificial Intelligence.
 IPDU: Intelligent Power Drive Unit
 ○: Lighting, □: Flashing, ●: Goes off
 ALT.: Flashing is alternately when there are two flashing LED.
 SIM: Simultaneous flashing when there are two flashing LED.

Wireless remote controller display	Check code		Wireless remote controller				Check code name	Judging device
	Outdoor 7-segment display	Auxiliary code	Sensor block display of receiving unit					
			OPERATION	TIMER	PRE.DEF.	Flash		
E01	—	—	□	●	●		Communication error between indoor and remote controller (Detected at remote controller side)	Remote controller
E02	—	—	□	●	●		Remote controller transmission error	Remote controller
E03	—	—	□	●	●		Communication error between indoor and remote controller (Detected at indoor side)	Indoor
E04	—	—	●	●	□		Communication circuit error between indoor/outdoor (Detected at indoor side)	Indoor
E06	E06	No. of indoor units in which sensor has been normally received	●	●	□		Decrease of No. of indoor units	I/F
—	E07	—	●	●	□		Communication circuit error between indoor/outdoor (Detected at outdoor side)	I/F
E08	E08	Duplicated indoor addresses	□	●	●		Duplicated indoor addresses	Indoor / I/F
E09	—	—	□	●	●		Duplicated main remote controllers	Remote controller
E10	—	—	□	●	●		Communication error between indoor MCU	Indoor
E12	E12	01: Indoor/Outdoor communication 02: Communication between outdoor units	□	●	●		Automatic address start error	I/F
E15	E15	—	●	●	□		Indoor is nothing during automatic addressing	I/F
E16	E16	00: Capacity over 01 -:No. of connected units	●	●	□		Capacity over / No. of connected indoor units	I/F
E18	—	—	□	●	●		Communication error between indoor units	Indoor
E19	E19	00: Header is nothing 02: Two or more header units	●	●	□		Outdoor header units quantity error	I/F
E20	E20	01: Outdoor of other line connected 02: Indoor of other line connected	●	●	□		Other line connected during automatic address	I/F
E22	E22	—	●	●	□		Reduction in number of heat storage units	I/F

E23	E23	—	●	●	□		Sending error in communication between outdoor units	I/F
E25	E25	—	●	●	□		Duplicated follower outdoor addresses	I/F
E26	E26	No. of outdoor units which received signal normally	●	●	□		Decrease of No. of connected outdoor units	I/F
E28	E28	Detected outdoor unit number	●	●	□		Follower outdoor unit error	I/F
E31	E31	Number of IPDU (*1)	●	●	□		IPDU communication error	I/F
F01	—	—	□	□	●	ALT	Indoor TCJ sensor error	Indoor
F02	—	—	□	□	●	ALT	Indoor TC2 sensor error	Indoor
F03	—	—	□	□	●	ALT	Indoor TC1 sensor error	Indoor
F04	F04	—	□	□	○	ALT	TD1 sensor error	I/F
F05	F05	—	□	□	○	ALT	TD2 sensor error	I/F
F06	F06	01: TE1 sensor 02: TE2 sensor	□	□	○	ALT	TE1 sensor error TE2 sensor error	I/F
F07	F07	—	□	□	○	ALT	TL sensor error	I/F
F08	F08	—	□	□	○	ALT	TO sensor error	I/F
F10	—	—	□	□	●	ALT	Indoor TA sensor error	Indoor
F12	F12	—	□	□	○	ALT	TS1 sensor error	I/F
F13	F13	01: Comp. 1 side 02: Comp. 2 side 03: Comp. 3 side	□	□	○	ALT	TH sensor error	IPDU
F15	F15	—	□	□	○	ALT	Outdoor temp. sensor miscabling (TE, TL)	I/F
F16	F16	—	□	□	○	ALT	Outdoor pressure sensor miscabling (Pd, Ps)	I/F
F22	F22	—	□	□	○	ALT	TD3 sensor error	I/F
F23	F23	—	□	□	○	ALT	Ps sensor error	I/F
F24	F24	—	□	□	○	ALT	Pd sensor error	I/F
F29	—	—	□	□	●	SIM	Indoor other error	Indoor
F31	F31	—	□	□	○	SIM	Indoor EEPROM error	I/F
H01	H01	01: Comp. 1 side 02: Comp. 2 side 03: Comp. 3 side	●	□	●		Compressor break down	IPDU
H02	H02	01: Comp. 1 side 02: Comp. 2 side 03: Comp. 3 side	●	□	●		Magnet switch error Overcurrent relay operation Compressor trouble (lock)	MG-SW Overcurrent relay IPDU
H03	H03	01: Comp. 1 side 02: Comp. 2 side 03: Comp. 3 side	●	□	●		Current detect circuit system error	IPDU
H04	H04	—	●	□	●		Comp 1 case thermo operation	I/F
H06	H06	—	●	□	●		Low pressure protective operation	I/F
H07	H07	—	●	□	●		Oil level down detective protection	I/F
H08	H08	01: TK1 sensor error 02: TK2 sensor error 03: TK3 sensor error 04: TK4 sensor error 05: TK5 sensor error	●	□	●		Oil level detective temp sensor error	I/F
H14	H14	—	●	□	●		Comp 2 case thermo operation	I/F
H15	H15	—	●	□	●		TD2 sensor miswiring	I/F
H16	H16	01: TK1 oil circuit system error 02: TK2 oil circuit system error 03: TK3 oil circuit system error 04: TK4 oil circuit system error 05: TK5 oil circuit system error	●	□	●		Oil level detective circuit error Magnet switch error Overcurrent relay operation	I/F MG-SW Overcurrent relay
H25	H25	—	●	□	●		TD3 sensor miswiring	I/F

L03	—	—	☐ ● ☐	SIM	Indoor centre unit duplicated	Indoor
L04	L04	—	☐ ○ ☐	SIM	Outdoor line address duplicated	I/F
L05	—	—	☐ ● ☐	SIM	Duplicated indoor units with priority (Displayed in indoor unit with priority)	I/F
L06	L06	No. of indoor units with priority	☐ ● ☐	SIM	Duplicated indoor units with priority (Displayed in unit other than indoor unit with priority)	I/F
L07	—	—	☐ ● ☐	SIM	Group line in individual indoor unit	Indoor
L08	L08	—	☐ ● ☐	SIM	Indoor group/Address unset	Indoor / I/F
L09	—	—	☐ ● ☐	SIM	Indoor capacity unset	Indoor
L10	L10	—	☐ ○ ☐	SIM	Outdoor capacity unset	I/F
L17	—	—	☐ ○ ☐	SIM	Outdoor unit type mismatch error	I/F
L20	—	—	☐ ○ ☐	SIM	Duplicated central control addresses	AI-NET, Indoor
L26	L26	Number of heat storage units connected	☐ ○ ☐	SIM	Too many heat storage units connected	I/F
L27	L27	Number of heat storage units connected	☐ ○ ☐	SIM	Error in number of heat storage units connected	I/F
L28	L28	—	☐ ○ ☐	SIM	Over No. of connected outdoor units	I/F
L29	L29	Number of IPDU (*1)	☐ ○ ☐	SIM	No. of IPDU error	I/F
L30	L30	Detected indoor address	☐ ○ ☐	SIM	Indoor outside interlock	Indoor
—	L31	—	—	—	Extended I/C error	I/F
P01	—	—	● ☐ ☐	ALT	Indoor fan motor error	Indoor
P03	P03	—	☐ ● ☐	ALT	Discharge temp. TD1 error	I/F
P04	P04	01: Comp. 1 side 02: Comp. 2 side 03: Comp. 3 side	☐ ● ☐	ALT	High-pressure SW system operation	IPDU
P05	P05	00: 01: Comp. 1 side 02: Comp. 2 side 03: Comp. 3 side	☐ ● ☐	ALT	Phase missing detection/Power failure detection Inverter DC voltage error (comp.) Inverter DC voltage error (comp.) Inverter DC voltage error (comp.)	I/F
P07	P07	01: Comp. 1 side 02: Comp. 2 side 03: Comp. 3 side	☐ ● ☐	ALT	Heat sink overheat error	IPDU, I/F
P09	P09	Detected heat storage address	● ☐ ☐	ALT	No heat storage unit water error	Heat storage unit
P10	P10	Detected indoor address	● ☐ ☐	ALT	Indoor overflow error	Indoor
P12	—	—	● ☐ ☐	ALT	Indoor fan motor error	Indoor
P13	P13	—	● ☐ ☐	ALT	Outdoor liquid back detection error	I/F
P15	P15	01: TS condition 02: TD condition	☐ ● ☐	ALT	Gas leak detection	I/F
P17	P17	—	☐ ● ☐	ALT	Discharge temp. TD2 error	I/F
P18	P18	—	☐ ● ☐	ALT	Discharge temp. TD3 error	I/F
P19	P19	Detected outdoor unit number	☐ ● ☐	ALT	4-way valve inverse error	I/F
P20	P20	—	☐ ● ☐	ALT	High-pressure protective operation	I/F
P22	P22	0*: IGBT circuit error 1*: Position detective circuit error 3*: Motor lock error 4*: Motor current detection C*: TH sensor error D*: TH sensor error E*: Inverter DC voltage error (outdoor unit fan)	☐ ● ☐	ALT	Outdoor fan IPDU error	IPDU
P26	P26	01: Comp. 1 side 02: Comp. 2 side 03: Comp. 3 side	☐ ● ☐	ALT	G-TR short protection error	IPDU

P29	P29	01: Comp. 1 side 02: Comp. 2 side 03: Comp. 3 side	☐ ● ☐	ALT	Comp position detective circuit system error	IPDU
P31	P31	—	☐ ● ☐	ALT	Other indoor unit error (Group terminal unit error)	Indoor
—	—	—	By alarm device	ALT	Error in indoor unit group	AI-NET
—	—	—	—	—	AI-NET communication system error	AI-NET
—	—	—	—	—	Duplicated network adapters	AI-NET

*1 Number of IPDU

01: Comp. 1
02: Comp. 2
03: Comp. 1 + Comp. 2
04: Comp. 3
05: Comp. 1 + Comp. 306: Comp. 2 + Comp. 3
07: Comp. 1 + Comp. 2 + Comp. 3
08: Fan
09: Comp. 1 + Fan
0A: Comp. 2 + Fan0B: Comp. 1 + Comp. 2 + Fan
0C: Comp. 3 + Fan
0D: Comp. 1 + Comp. 3 + Fan
0E: Comp. 2 + Comp. 3 + Fan
0F: Comp. 1 + Comp. 2 + Comp. 3 + Fan**Error detected by TCC-LINK central control device**

Central control device indication	Check code		Wireless remote controller			Check code name	Judging device	
	Outdoor 7-segment display	Sensor block display of receiving unit	OPERATION	TIMER	PREDEF.			Flash
C05	—	—	—	—	—	—	Sending error in TCC-LINK central control device	TCC-LINK
C06	—	—	—	—	—	—	Receiving error in TCC-LINK central control device	TCC-LINK
C12	—	—	—	—	—	—	Batch alarm of general-purpose equipment control interface	General-purpose equipment I/F
P30	Differs according to error contents of unit with occurrence of alarm						Group control branching unit error	TCC-LINK
	—	—	(L20 is displayed.)				Duplicated central control addresses	

TCC-LINK: TOSHIBA Carrier Communication Link.

WARNINGS ON REFRIGERANT LEAKAGE

Check of Concentration Limit

The room in which the air conditioner is to be installed requires a design that in the event of refrigerant gas leaking out, its concentration will not exceed a set limit.

The refrigerant R410A which is used in the air conditioner is safe, without the toxicity or combustibility of ammonia, and is not restricted by laws to be imposed which protect the ozone layer. However, since it contains more than air, it poses the risk of suffocation if its concentration should rise excessively. Suffocation from leakage of R410A is almost non-existent. With the recent increase in the number of high concentration buildings, however, the installation of multi air conditioner systems is on the increase because of the need for effective use of floor space, individual control, energy conservation by curtailing heat and carrying power etc. Most importantly, the multi air conditioner system is able to replenish a large amount of refrigerant compared with conventional individual air conditioners. If a single unit of the multi conditioner system is to be installed in a small room, select a suitable model and installation procedure so that if the refrigerant accidentally leaks out, its concentration does not reach the limit (and in the event of an emergency, measures can be made before injury can occur). In a room where the concentration may exceed the limit, create an opening with adjacent rooms, or install mechanical ventilation combined with a gas leak detection device.

The concentration is as given below.

$$\frac{\text{Total amount of refrigerant (kg)}}{\text{Min. volume of the indoor unit installed room (m}^3\text{)} \leq \text{Concentration limit (kg/m}^3\text{)}$$

The concentration limit of R410A which is used in multi air conditioners is 0.44 kg/m³.

NOTE 1 :

If there are 2 or more refrigerating systems in a single refrigerating device, the amounts of refrigerant should be as charged in each independent device.

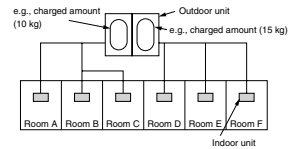

For the amount of charge in this example:

The possible amount of leaked refrigerant gas in rooms A, B and C is 10 kg.
The possible amount of leaked refrigerant gas in rooms D, E and F is 15 kg.

Important

NOTE 2 :

The standards for minimum room volume are as follows.

- (1) No partition (shaded portion)

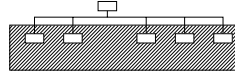

- (2) When there is an effective opening with the adjacent room for ventilation of leaking refrigerant gas (opening without a door, or an opening 0.15% or larger than the respective floor spaces at the top or bottom of the door).

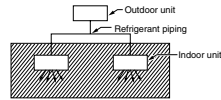

- (3) If an indoor unit is installed in each partitioned room and the refrigerant piping is interconnected, the smallest room of course becomes the object. But when a mechanical ventilation is installed interlocked with a gas leakage detector in the smallest room where the density limit is exceeded, the volume of the next smallest room becomes the object.

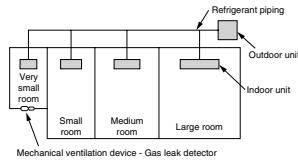

NOTE 3 :

The minimum indoor floor area compared with the amount of refrigerant is roughly as follows: (When the ceiling is 2.7 m high)

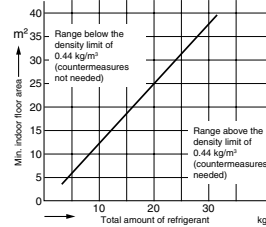

CONFIRMATION OF INDOOR UNIT SETUP

Prior to delivery to the customer, check the address and setup of the indoor unit, which has been installed in this time and fill the check sheet (Table below). Data of four units can be entered in this check sheet.

Copy this sheet according to the No. of the indoor units. If the installed system is a group control system, use this sheet by entering each line system into each installation manual attached to the other indoor units.

REQUIREMENT

This check sheet is required for maintenance after installation. Be sure to fill this sheet and then pass this Installation Manual to the customers.

Indoor unit setup check sheet

Indoor unit			Indoor unit			Indoor unit			Indoor unit		
Room name			Room name			Room name			Room name		
Model			Model			Model			Model		
Check indoor unit address. (For check method, refer to Applicable controls in this sheet.)											
* In case of a single system, it is unnecessary to enter the indoor address. (CODE No.: Line [12], Indoor [13], Central control [03])											
Line	Indoor	Group	Line	Indoor	Group	Line	Indoor	Group	Line	Indoor	Group
Central control address			Central control address			Central control address			Central control address		
Various setup			Various setup			Various setup			Various setup		
Have you changed high ceiling setup? If not, fill check mark [x] in [NO CHANGE], and fill check mark [x] in [ITEM] if changed, respectively. (For check method, refer to Applicable controls in this sheet.) * In case of replacement of short plugs on indoor microcomputer P.C. board, setup is automatically changed.											
High ceiling setup (CODE No. [5d])			High ceiling setup (CODE No. [5d])			High ceiling setup (CODE No. [5d])			High ceiling setup (CODE No. [5d])		
<input type="checkbox"/> NO CHANGE			<input type="checkbox"/> NO CHANGE			<input type="checkbox"/> NO CHANGE			<input type="checkbox"/> NO CHANGE		
<input type="checkbox"/> STANDARD [0000]			<input type="checkbox"/> STANDARD [0000]			<input type="checkbox"/> STANDARD [0000]			<input type="checkbox"/> STANDARD [0000]		
<input type="checkbox"/> HIGH CEILING 1 [0001]			<input type="checkbox"/> HIGH CEILING 1 [0001]			<input type="checkbox"/> HIGH CEILING 1 [0001]			<input type="checkbox"/> HIGH CEILING 1 [0001]		
<input type="checkbox"/> HIGH CEILING 3 [0003]			<input type="checkbox"/> HIGH CEILING 3 [0003]			<input type="checkbox"/> HIGH CEILING 3 [0003]			<input type="checkbox"/> HIGH CEILING 3 [0003]		
Have you changed lighting time of filter sign? If not, fill check mark [x] in [NO CHANGE], and fill check mark [x] in [ITEM] if changed, respectively. (For check method, refer to Applicable controls in this sheet.)											
Filter sign lighting time (CODE No. [01])			Filter sign lighting time (CODE No. [01])			Filter sign lighting time (CODE No. [01])			Filter sign lighting time (CODE No. [01])		
<input type="checkbox"/> NO CHANGE			<input type="checkbox"/> NO CHANGE			<input type="checkbox"/> NO CHANGE			<input type="checkbox"/> NO CHANGE		
<input type="checkbox"/> NONE [0000]			<input type="checkbox"/> NONE [0000]			<input type="checkbox"/> NONE [0000]			<input type="checkbox"/> NONE [0000]		
<input type="checkbox"/> 150H [0001]			<input type="checkbox"/> 150H [0001]			<input type="checkbox"/> 150H [0001]			<input type="checkbox"/> 150H [0001]		
<input type="checkbox"/> 2500H [0002]			<input type="checkbox"/> 2500H [0002]			<input type="checkbox"/> 2500H [0002]			<input type="checkbox"/> 2500H [0002]		
<input type="checkbox"/> 5000H [0003]			<input type="checkbox"/> 5000H [0003]			<input type="checkbox"/> 5000H [0003]			<input type="checkbox"/> 5000H [0003]		
<input type="checkbox"/> 10000H [0004]			<input type="checkbox"/> 10000H [0004]			<input type="checkbox"/> 10000H [0004]			<input type="checkbox"/> 10000H [0004]		
Have you changed detected temp. shift value? If not, fill check mark [x] in [NO CHANGE], and fill check mark [x] in [ITEM] if changed, respectively. (For check method, refer to Applicable control in this sheet.)											
Detected temp. shift value setup (CODE No. [06])			Detected temp. shift value setup (CODE No. [06])			Detected temp. shift value setup (CODE No. [06])			Detected temp. shift value setup (CODE No. [06])		
<input type="checkbox"/> NO CHANGE			<input type="checkbox"/> NO CHANGE			<input type="checkbox"/> NO CHANGE			<input type="checkbox"/> NO CHANGE		
<input type="checkbox"/> NO SHIFT [0000]			<input type="checkbox"/> NO SHIFT [0000]			<input type="checkbox"/> NO SHIFT [0000]			<input type="checkbox"/> NO SHIFT [0000]		
<input type="checkbox"/> +1°C [0001]			<input type="checkbox"/> +1°C [0001]			<input type="checkbox"/> +1°C [0001]			<input type="checkbox"/> +1°C [0001]		
<input type="checkbox"/> +2°C [0002]			<input type="checkbox"/> +2°C [0002]			<input type="checkbox"/> +2°C [0002]			<input type="checkbox"/> +2°C [0002]		
<input type="checkbox"/> +3°C [0003]			<input type="checkbox"/> +3°C [0003]			<input type="checkbox"/> +3°C [0003]			<input type="checkbox"/> +3°C [0003]		
<input type="checkbox"/> +4°C [0004]			<input type="checkbox"/> +4°C [0004]			<input type="checkbox"/> +4°C [0004]			<input type="checkbox"/> +4°C [0004]		
<input type="checkbox"/> +5°C [0005]			<input type="checkbox"/> +5°C [0005]			<input type="checkbox"/> +5°C [0005]			<input type="checkbox"/> +5°C [0005]		
<input type="checkbox"/> +6°C [0006]			<input type="checkbox"/> +6°C [0006]			<input type="checkbox"/> +6°C [0006]			<input type="checkbox"/> +6°C [0006]		
Incorporation of parts sold separately			Incorporation of parts sold separately			Incorporation of parts sold separately			Incorporation of parts sold separately		
Have you incorporated the following parts sold separately? If incorporated, fill check mark [x] in each [ITEM]. (When incorporating, the setup change is necessary in some cases. For setup change method, refer to Installation Manual attached to each part sold separately.)											
Panel			Panel			Panel			Panel		
<input type="checkbox"/> Standard panel			<input type="checkbox"/> Standard panel			<input type="checkbox"/> Standard panel			<input type="checkbox"/> Standard panel		
Filter			Filter			Filter			Filter		
<input type="checkbox"/> Super long life filter			<input type="checkbox"/> Super long life filter			<input type="checkbox"/> Super long life filter			<input type="checkbox"/> Super long life filter		
<input type="checkbox"/> Others ()			<input type="checkbox"/> Others ()			<input type="checkbox"/> Others ()			<input type="checkbox"/> Others ()		
<input type="checkbox"/> Others ()			<input type="checkbox"/> Others ()			<input type="checkbox"/> Others ()			<input type="checkbox"/> Others ()		

13. P.C. BOARD EXCHANGE PROCEDURES

Model type	P.C. board model	Label display on P.C. board
MML-AP *** 4NH series	MCC-1510	WP-025

[Requirement when replacing the service indoor P.C. board assembly]

In the non-volatile memory (Hereinafter said EEPROM, IC10) installed on the indoor P.C. board before replacement, the type and capacity code exclusive to the corresponding model have been stored at shipment from the factory and the important setup data such as refrigerant line /indoor unit /group address in (AUTO/MANUAL) mode have been stored at installation.

Replace the service indoor P.C. board assembly according to the following procedure.

After replacement, make sure that the indoor unit address is set correctly and also the refrigerant cycle is working correctly by test operation.

<Replacement procedure>

CASE 1

Before replacement, power of the indoor unit can be turned on and the setup data can be readout by the wired remote controller.

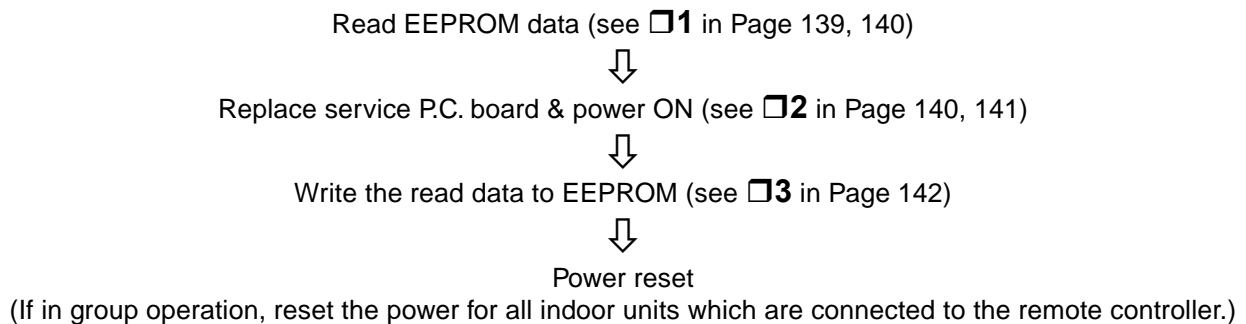

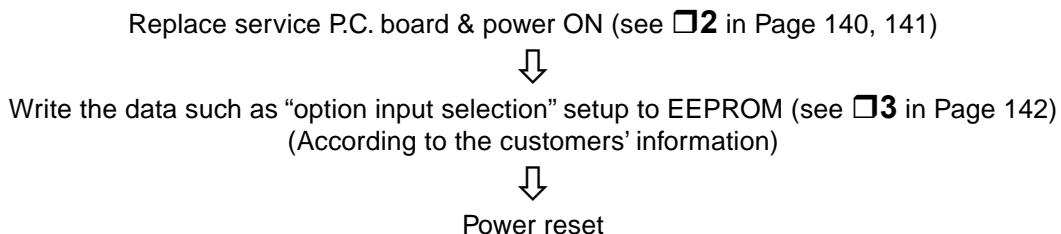

CASE 2

Before replacement, the setup data can not be read out by the wired remote controller.



□1 Readout of the setup data from EEPROM

(Data in EEPROM contents, which have been changed at the local site, are read out together with data in EEPROM set at shipment from the factory.)

1. Push ,  and  buttons of the remote controller at the same time for 4 seconds or more. **1**
(Corresponded with No. in Remote controller as shown below picture)

* When group operation, the header indoor unit address is displayed at the first time. In this time, the CODE No. (DN)  is displayed. The fan of the second indoor unit operates and the flap starts swinging if any.

2. Every pushing [Unit, Louver ^{UNIT LOUVER}] button, the indoor unit address in the group are displayed successively. **2**
Specify the indoor unit No. to be replaced.
3. Using the set temperature ∇ / \blacktriangle buttons, the CODE No. (DN) can be moved up and down one by one. **3**
4. First change the CODE No. (DN) from *10* to *01*. (Setting of filter sign lighting time)
Make a note of the set data displayed in this time.
5. Next change the CODE No. (DN) using the set temperature ∇ / \blacktriangle buttons.
Also make a note of the set data.
6. Repeat item 5. and made a note of the important set data as shown in the below table.
* *01* to *AA* are provided in the CODE No. (DN). On the way of operation, DN No. may skip.
7. After finishing making a note, push ^{TEST} button to return to the usual stop status. **4**
(Approx. 1 minute is required to be able to use the remote controller.)

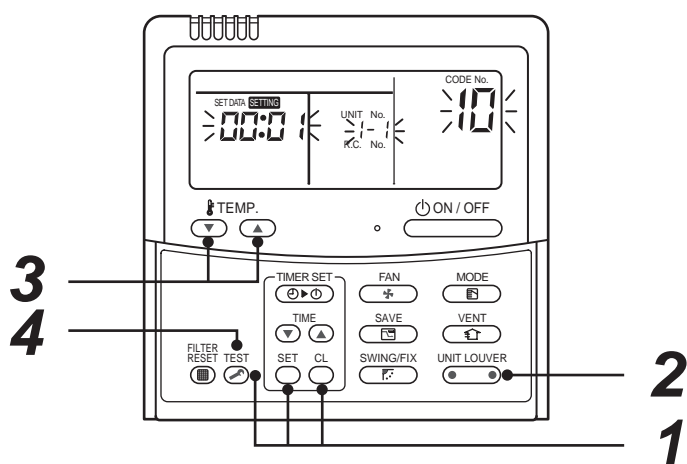

Minimum requirements for CODE No.

DN	Contents
11	Indoor unit capacity
12	Refrigerant line address
13	Indoor unit address
14	Group address

Capacity of the indoor unit is necessary to set the revolutions of the fan.

□2 Replacement of service P.C. board

1. Replace the P.C. board with a service P.C. board.

In this time, setting of jumper line (cut) or setting of DIP switch on the former P.C. board should be reflected on the service P.C. board. Refer to the following table about DIP switch setting and drawing of P.C. board parts layout.

2. It is necessary to set Indoor unit to be exchanged : Remote controller = 1 : 1

Based upon the system configuration, turn on power of the indoor unit with one of the following items.

- 1) Single (Individual) operation

Turn on power of the indoor units and proceed to □3.

- 2) Group operation

A) In case that power of the exchanged indoor unit only can be turned on.

Turn on power of the exchanged indoor unit only and proceed to □3.

B) In case that power of the indoor units cannot be turned on individually. (**CASE 1**)

a) Remove temporarily the group wire connected to the terminal blocks A and B of the exchanged indoor unit.

b) After connecting the remote controller wire only to the removed terminal block, turn on power of the indoor units and proceed to □3.

* When the above methods cannot be used, follow at the **CASE 2** below.

C) In case that power of the indoor units cannot be turned in individually. (**CASE 2**)

- a) Remove all CN41 connectors of the indoor units in the same group except those of the exchanged indoor unit.
 - b) Turn on power of the indoor units and proceed to **□3**.
- * After **□3** operation has finished, be sure to return the temporarily removed group wire or CN41 connector to the original connection.

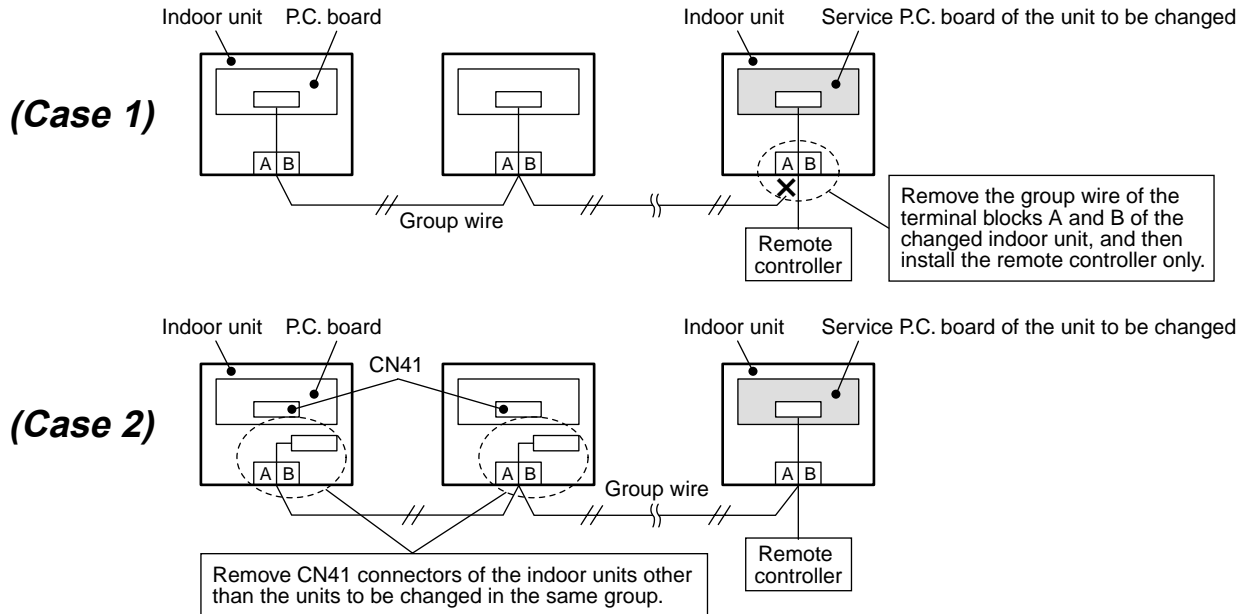

P.C. board parts layout drawing

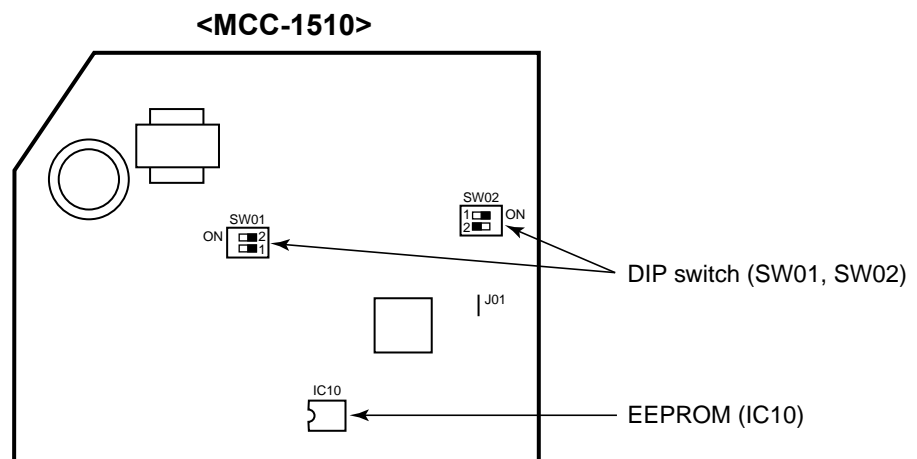

Method of DIP switch setting

		Selected content	MML-AP *** 4NH series	At shipment
SW01	Bit 1	Terminator resistor (for central control)	* 1	OFF (Without terminator)
	Bit 2	Remote controller A/B selection	* 1	OFF (A selection)
SW02	Bit 1	Custom / Multi model selection	ON	ON (Multi model)
	Bit 2	No use	OFF	OFF

*1 : Match to set up contents of P.C. board before replacement.

□3 3 Writing of the setup contents to EEPROM

(The contents of EEPROM installed on the service P.C. board have been set up at shipment from the factory.)

1. Push ^{SET}○, ^{CL}○ and ^{TEST}⊗ buttons of the remote controller at the same time for 4 seconds or more. **1**
(Corresponded with No. in Remote controller as shown below picture) (The UNIT No. *ALL* is displayed.)
In this time, the CODE No. (DN) *10* is displayed.
The fan of the indoor unit operates and the flap starts swinging if any.
 2. Using the set temperature ▼ / ▲ buttons, the CODE No. (DN) can be moved up and down one by one. **2**
 3. First set the capacity of the indoor unit.
(Setting the capacity writes the data at shipment from the factory in EEPROM.)
 - 1) Using the set temperature ▼ / ▲ buttons, set *11* to the CODE No. (DN). **2**
 - 2) Using the timer time ▼ / ▲ buttons, set the capacity. **3**
(For example, 0005 for MMK-AP0123H) Refer to the attached table.
 - 3) Push ^{SET}○ button. (OK when the display goes on.) **4**
 - 4) Push ^{TEST}⊗ button to return to usual stop status. **5**
(Approx. 1 minute is required to start handling of the remote controller.)
 4. Next write the contents that have been written at the installation such as the address data into EEPROM.
Repeat the above procedure 1.
 5. Using the set temperature ▼ / ▲ buttons, set *01* to the CODE No. (DN). **2**
(Setup of lighting time of filter sign)
 6. The contents of the displayed setup data in this time should be agreed with the contents in the previous memorandum in □1.
 - 1) If data disagree, change the displayed setup data to that in the previous memorandum by the timer time ▼ / ▲ buttons, and then push ^{SET}○ button. (OK when the display goes on.)
 - 2) There is nothing to do when data agrees.
 7. Using the set temperature ▼ / ▲ buttons, change the CODE No. (DN).
As same as the above 6., check the contents of the setup data and then change them to data contents in the previous memorandum in □1.
 8. Then repeat the procedure 6. and 7.
 9. After completion of setup, push ^{TEST}⊗ button to return the status to the usual stop status. **5**
In a group operation, turn off the power supply once, return the group wires between indoor units and CN41 connectors as before, and then turn on power of all the indoor units.
(Approx. 1 minute is required to be able to use of the remote controller.)
- * *01* to *AA* are provided in the CODE No. (DN). On the way of operation, DN No. may skip.
When data has been changed by mistake and ^{SET}○ button has been pushed, the data can be returned to the data before change by pushing ^{CL}○ button if the CODE No. (DN) was not yet changed.

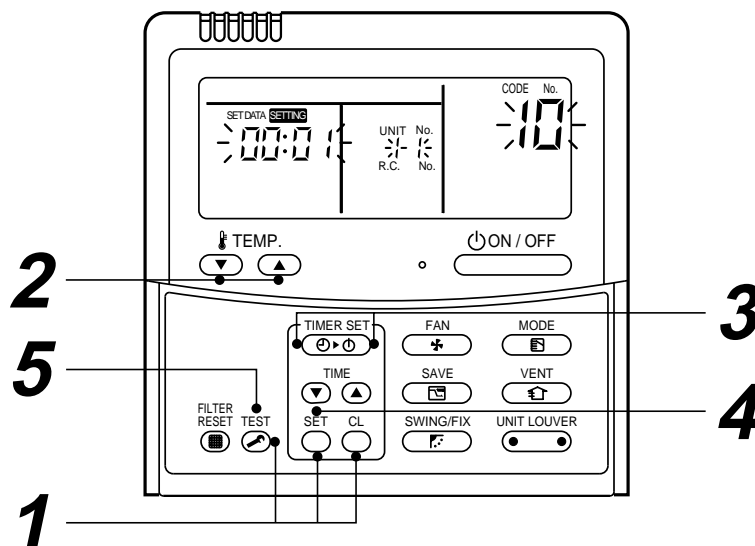

CODE No. table (Please record the objective unit data at field)

DN	Item	Memo	At shipment
01	Filter sign lighting time		0001: 150 hour
02	Dirty state of filter		0000: Standard
03	Central control address		0099: Unfixed
06	Heating suction temp shift		0000: No shift
0C	PRE-DEF indication selection		0000: Standard
0d	Cooling auto mode existence		0001: No auto mode cooling/heating
0F	Cooling only		0000: Heat pump
10	Type	Be sure to set as 0018	0018: Console type
11	Indoor unit capacity (See below table)		According to capacity type
12	Refrigerant line address		0099: Unfixed
13	Indoor unit address		0099: Unfixed
14	Group address		0099: Unfixed
1E	Temp difference of automatic cooling/heating selecting control points		0003: 3deg (Ts ± 1.5)
28	Automatic restart from power cut		0000: None
2A	Option input selection (CN80)		0002: External emergency input
2b	Thermo output selection (T10 ③)		0000: Thermo ON
2E	Input selection (T10 ①)		0000: Operation input
32	Sensor selection		0000: Body TA sensor
60	Timer set (Wired remote controller)		0000: Available
69	Louver selection of cooling		0000: Standard

Indoor unit capacity (CODE No. [11])

Setup data	Model
0001*	Invalid
0001	MML-AP0074NH
0003	MML-AP0094NH
0005	MML-AP0124NH
0007	MML-AP0154NH
0009	MML-AP0184NH

* Initial value of EEPROM installed on the supplied service P.C. board

14. DETACHMENTS

WARNING

- Since high voltages pass through the electrical parts, turn off the power without fail before proceeding with the repairs.
Electric shocks may occur if the main power supply switch or breakers are not turned off.
 - After the repairs have been completed (after the front panel and cabinet have been installed), perform a test run, and check for smoking, unusual sounds and other abnormalities.
If this check is omitted, a fire and/or electric shocks may occur.
Before proceeding with the test run, install the front panel and cabinet.
 - Ensure that the following steps are taken when doing repairs on the refrigerating cycle.
 1. Do not allow any naked flames in the surrounding area.
If a gas stove or other appliance is being used, extinguish the flames before proceeding.
If the flames are not extinguished, they may ignite any oil mixed with the refrigerant gas.
 2. Do not use welding equipment in an airtight room.
Carbon monoxide poisoning may result if the room is not properly ventilated.
 3. Do not bring welding equipment near flammable objects.
Flames from the equipment may cause the flammable objects to catch fire.
 - **If keeping the power on is absolutely unavoidable while doing a job such as inspecting the circuitry, wear rubber gloves to avoid contact with the live parts.**
Electric shocks may be received if the live parts are touched.
High-voltage circuits are contained inside this unit.
Proceed very carefully when conducting checks since directly touching the parts on the control circuit board may result in electric shocks.
-

WARNING

- Since high voltages pass through the electrical parts, turn off the power without fail before proceeding with the repairs.

Electric shocks may occur if the power plug is not disconnected.

- After the repairs have been completed (after the front panel and cabinet have been installed), perform a test run, and check for smoking, unusual sounds and other abnormalities.

If this check is omitted, a fire and/or electric shocks may occur.

Before proceeding with the test run, install the front panel and cabinet.

- Ensure that the following steps are taken when doing repairs on the refrigerating cycle.

1. Do not allow any naked flames in the surrounding area.

If a gas stove or other appliance is being used, extinguish the flames before proceeding.

If the flames are not extinguished, they may ignite any oil mixed with the refrigerant gas.

2. Do not use welding equipment in an airtight room.

Carbon monoxide poisoning may result if the room is not properly ventilated.

3. Do not bring welding equipment near flammable objects.

Flames from the equipment may cause the flammable objects to catch fire.

- **If keeping the power on is absolutely unavoidable while doing a job such as inspecting the circuitry, wear rubber gloves to avoid contact with the live parts.**



Electric shocks may be received if the live parts are touched.

High-voltage circuits are contained inside this unit.

Proceed very carefully when conducting checks since directly touching the parts on the control circuit board may result in electric shocks.

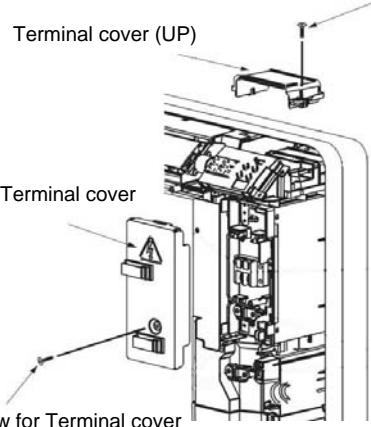
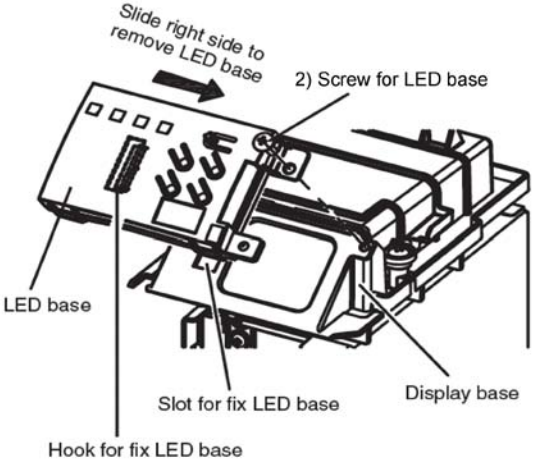
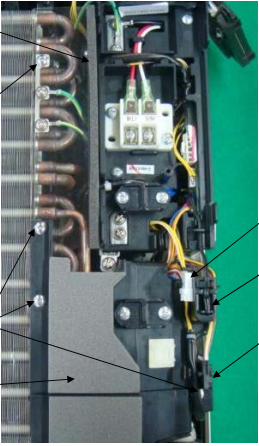
No.	Part name	Procedure	Remarks
①	Front panel	<p>1) Stop operation of the air conditioner and turn off the main power supply.</p> <p>2) Grip the air inlet grille by two hands at the handle positions.</p> <p>3) Pull the air inlet grille as the arrow direction and remove the rope from the hook of front panel.</p> <p>4) Remove screws for front panel. (4 pcs)</p>	<p>Air inlet grille</p> <p>Hook of front panel</p> <p>Rope</p> <p>4) Screws of front panel (4 pcs)</p>

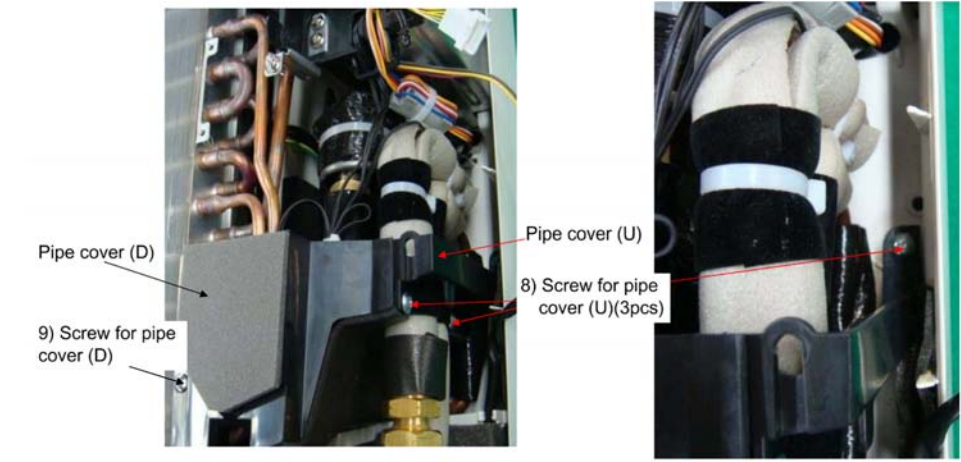
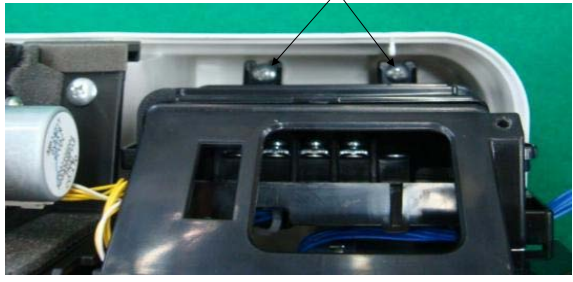

No.	Part name	Procedure	Remarks
②	Electrical parts Box assembly (E-box)	<p>1) Remove screw for Terminal cover (UP). 2) Remove screw for LED base.</p> <div data-bbox="384 365 836 539" style="border: 1px solid black; padding: 5px; margin: 10px 0;"> <p>NOTE Take off control wire and wired remote controller wire before it removes E-box cover. Otherwise, defective control might be caused.</p> </div> <p>3) Remove screw for E-box cover.</p> <p>4) Remove damper motor connector, flow selector connector and TA sensor from pipe cover (F).</p> <p>5) Take off damper motor connector.</p> <p>6) Remove screw for pipe cover (F). (3 pcs)</p> <p>7) Remove screw for drain guide (UP).</p>	<p>1) Screw for Terminal cover (UP)</p>  <p>3) Screw for Terminal cover</p> <p>Slide right side to remove LED base</p> <p>2) Screw for LED base</p>  <p>4) Damper motor connector</p> <p>4) TA sensor</p> <p>4) Flow selector connector</p>  <p>Drain guide (UP)</p> <p>7) Screw for drain guide (UP)</p> <p>6) Screw for pipe cover (F) (3pcs)</p> <p>Pipe cover (F)</p>

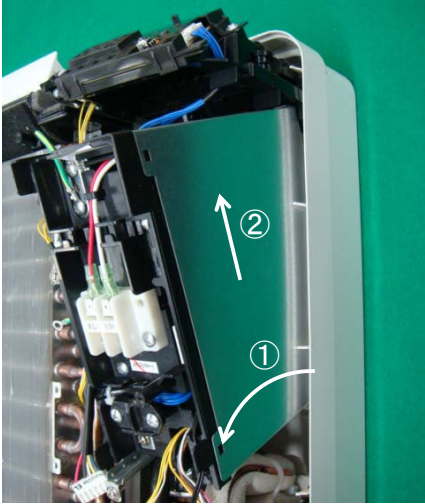
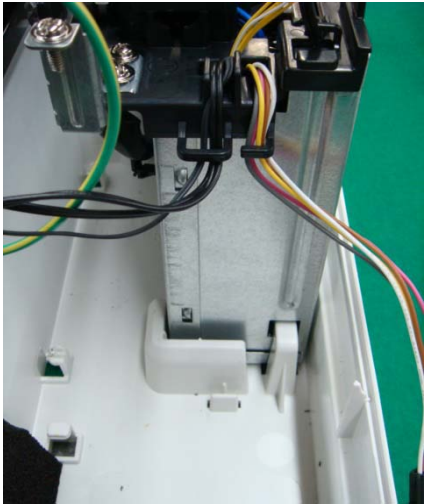
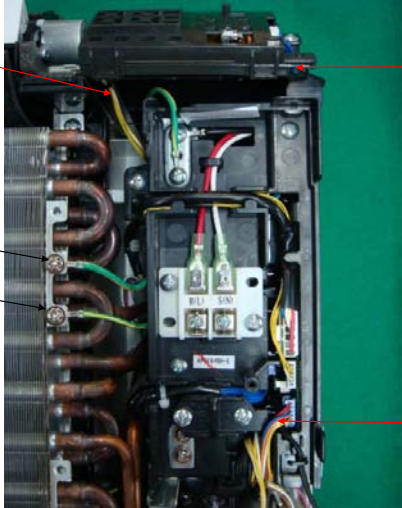

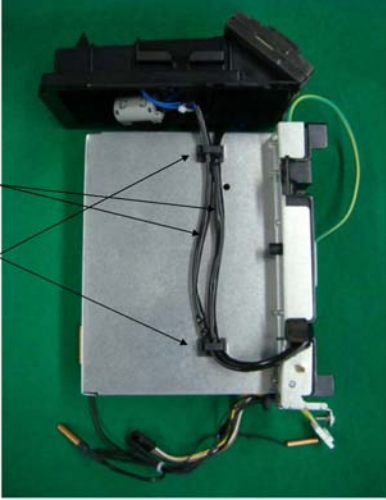
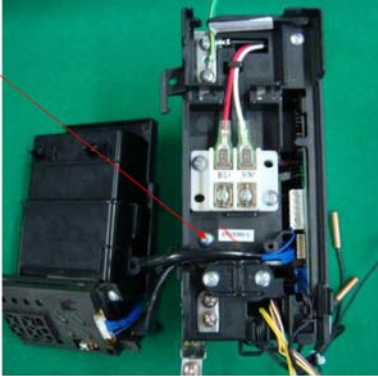
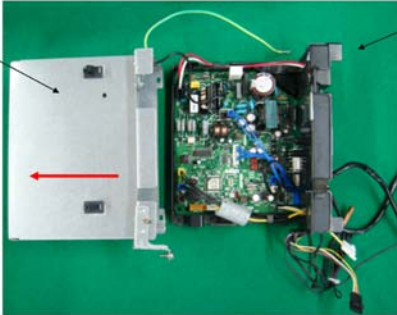

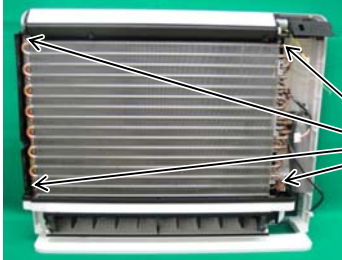
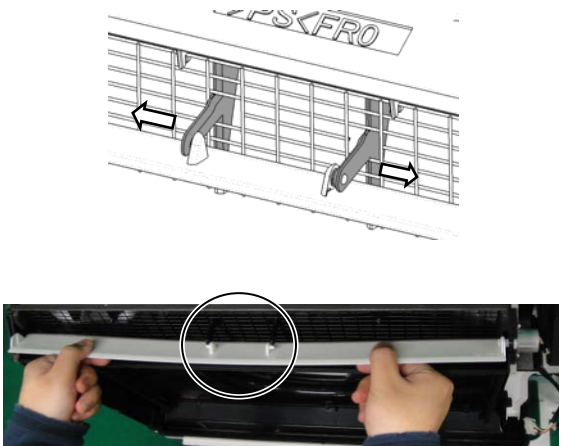

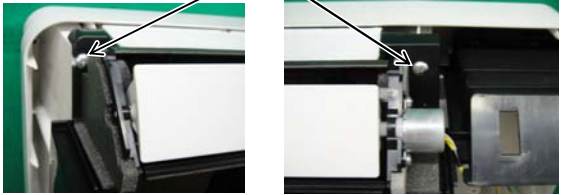
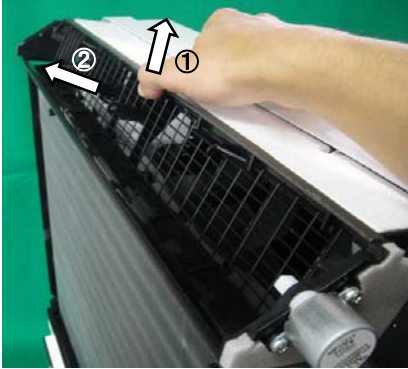
No.	Part name	Procedure	Remarks
②	Electrical parts Box assembly (E-box)	<p>8) Remove screw for pipe cover (U). (3 pcs)</p> <p>9) Remove screw for pipe cover (D).</p> <p>10) Remove screw for display base.</p> <p>11) Remove screw for earth-lead. (2 pcs)</p> <p>12) Pull off the TC1, TC2, TCJ sensor.</p>	  

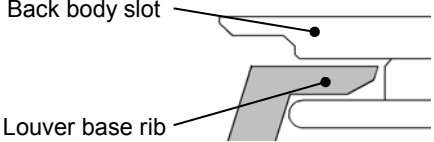
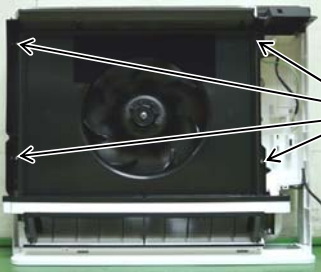
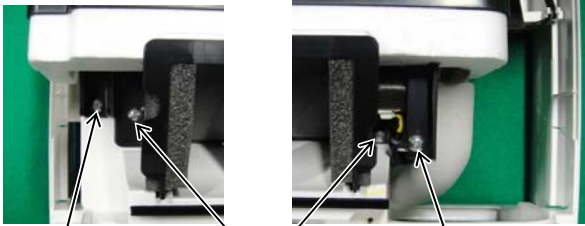
No.	Part name	Procedure	Remarks
②	Electrical parts Box assembly (E-box)	<p>13) Take off PMV motor connector. 14) Take off louver motor connector. 15) Take off fan motor connector. 16) Remove screw for E-box</p> <p>17) - ① Pull the upper part of the E-box. 18) - ② Lift a E-box in the upward for take off from the hook.</p>	   <p><How to arrange the lead> Shown in the picture</p> 

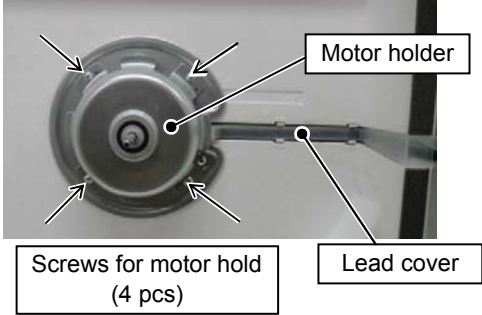
No.	Part name	Procedure	Remarks
②	Electrical parts Box assembly (E-box)	<p data-bbox="411 277 847 371"><How to remove P.C. board ASSY> 19) Remove protection tube for lead from cord clamp. (2pcs)</p> <p data-bbox="411 898 804 958">20) Remove screw to fix sub base to E-box.</p> <div data-bbox="411 987 866 1160" style="border: 1px solid black; padding: 5px;"> <p data-bbox="419 1003 852 1149">NOTE Remove protection tube from cord clamp before it pulls out E-box. Otherwise, the breakdown in the disconnection etc. might be caused.</p> </div> <p data-bbox="411 1379 767 1408">21) Pull out E-box from sub base.</p>	<div data-bbox="932 286 1453 790">  <p data-bbox="932 461 1050 506">19) protection tube</p> <p data-bbox="963 539 1054 562">Cord clamp</p> </div> <div data-bbox="932 909 1453 1283">  <p data-bbox="932 920 1070 965">Screw to fix sub base to E-box.</p> </div> <div data-bbox="932 1384 1453 1697">  <p data-bbox="932 1417 970 1440">E-box</p> <p data-bbox="1393 1406 1453 1429">Sub base</p> </div>

No.	Part name	Procedure	Remarks
③	PMV motor	<p><Cautions at work> Using spanners by 14mm,17mm and 19mm, remove the PMV motor. To avoid deformation of the pipes, do not use a monkey wrench. 1) Perform work of item ① . 2) Perform work of item ② . 3) Remove the bundling band of PMV motor lead wire. 4) Pull off butyl of PMV main unit until the position shown in the right photo. 5) Using a spanner, remove PMV.</p> <p><Caution in reassembling> Determine PMV motor lead wire drawing-out position as same as that before removing. Return butyl rubber to the original position.</p>	 <p>Spanner push-in part (Motor size:19mm)</p> <p>Spanner push-in part Main unit size MML-AP0074 to 0124 type:14mm MML-AP0154 to 0184 type:17mm</p> <p>Butyl rubber</p>
m	Heat exchanger (Refrigerant cycle assembly)	1) Take off the pipe holder. 2) Remove screws for heat exchanger. (4 pcs)	 <p>Screws for heat exchanger (4 pcs)</p>
n	Horizontal louver	Open a horizontal louver outward and stretch the arm of louver base same as the direction in the picture.	

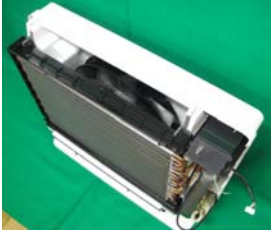
No.	Part name	Procedure	Remarks
○	Louver base assembly	<p>1) Remove screws for louver base. (2 pcs)</p> <p>2) - ① Pull the upper part of the louver base to upward.</p> <p>2) - ② Take off the louver base by pull out in the front direction.</p> <p><Attention for louver base assemble> Insert the rib of the louver base into the slot of back body same as the picture.</p>	<p>Screws for louver base (2 pcs)</p>    <p>Back body slot</p> <p>Louver base rib</p> 
p	Bell mouth	1) Remove screws for bell mouth. (4 pcs)	 <p>Screws for bell mouth (4 pcs)</p>
q	Drain pan and damper base	<p>1) Remove screws for drain pan. (2 pcs)</p> <p>2) Remove screws for damper base. (2 pcs)</p>	 <p>Screws for damper base (2 pcs)</p> <p>Screw for drain pan</p> <p>Screw for drain pan</p>

No.	Part name	Procedure	Remarks
Γ	Turbo fan	<p>1) Turn the flange nut (M10) in the counter-clockwise direction and take it off.</p> <p>2) Pull out the turbo fan from the fan motor shaft.</p> <p><Attention for turbo fan assemble> The tightening torque of the flange nut is 5N·m.</p>	
⑩	Fan motor	<p>1) Remove screws for motor holder, and take off the motor holder.</p> <p>2) Take off the lead cover.</p> <p><Attention for motor holder assemble> 1. Arrange the earth lead and fan motor lead. 2. Adjust the motor axis to the center of the motor holder then fix screws 4 pcs.</p>	   
⑪	Fan motor	<p>A method to take off a fan motor in a condition taking on a heat exchanger.</p> <p>1) Take off pipe holder and remove screws for heat exchanger. (refer to ③)</p> <p>2) Remove screws for the bell mouth. (refer to ⑥)</p>	 

No.	Part name	Procedure	Remarks
⑪	Fan motor	<p>3) Remove the flange nut and turbo fan. (refer to ⑧)</p> <p>4) Remove screws for motor holder and lead cover. (refer to ⑨)</p>	

Microcomputer

No.	Part name	Procedure	Remarks
①	Common procedure	<ol style="list-style-type: none">1) Turn the power supply off to stop the operation of air-conditioner.2) Remove the front panel.<ul style="list-style-type: none">• Remove the 2 fixing screws.3) Remove the electrical part base.	Replace terminal block, microcomputer ass'y and the P.C. board ass'y.

15. EXPLODED VIEWS AND PARTS LIST

15-1. Indoor Unit

Model: MML-AP0074NH-E, MML-AP0094NH-E, MML-AP0124NH-E, MML-AP0154NH-E, MML-AP0184H-E

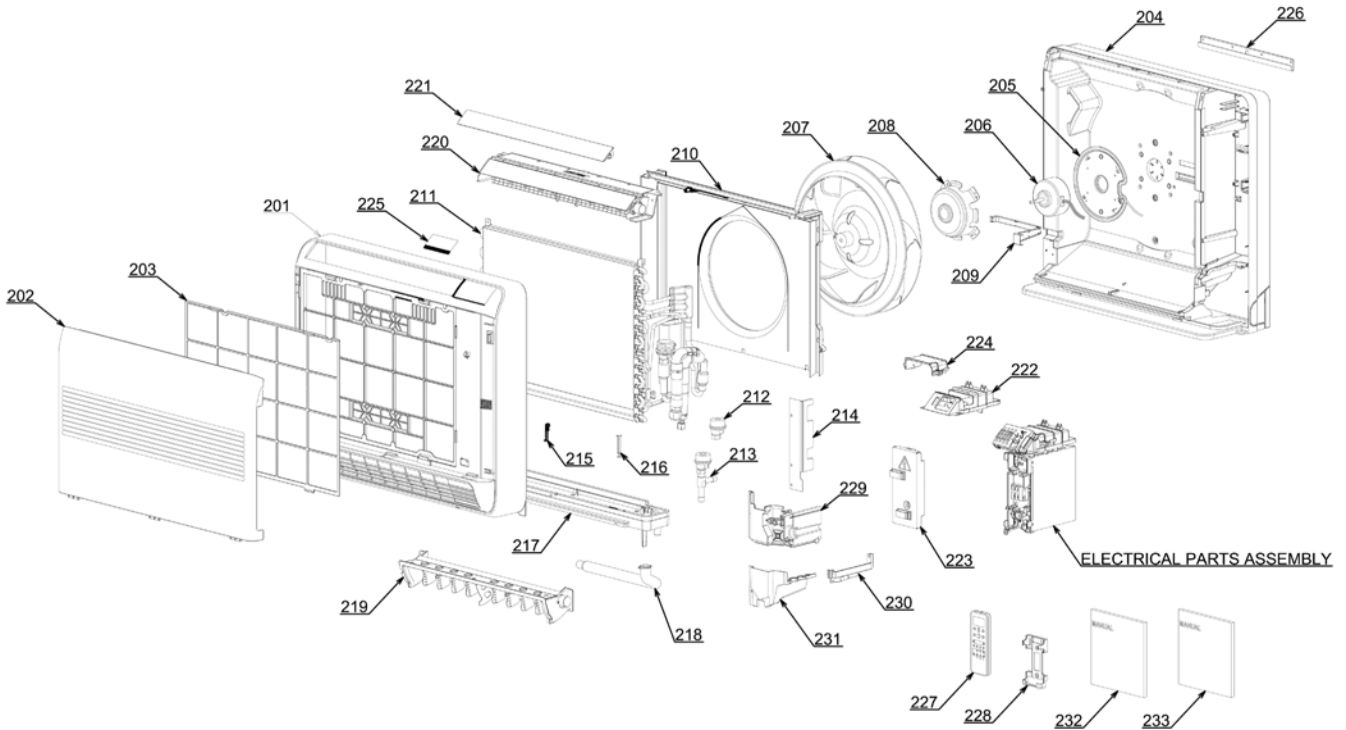

Location No.	Part No.	Description	Location No.	Part No.	Description
201	43T00558	FRONT PANEL ASSY	215	43T19333	HOLDER, SENSOR
202	43T09460	INLET GRILLE ASSY	216	43T19321	FIX-P-SENSOR
203	43T80325	AIR FILTER	217	43T72310	DRAIN PAN ASSY
204	43T03383	BACK BODY ASSY	218	43T70313	HOSE, DRAIN
205	43T39340	MOTOR BASE ASSY	219	43T22318	DAMPER ASSY
206	43T21424	FAN MOTOR ASSY	220	43T22320	UPPER LOUVER ASSY
207	43T20330	TURBO FAN ASSY	221	43T22315	HORIZONTAL LOUVER
208	43T60408	MOTOR HOLDER	222	43T63336	DISPLAY BASE
209	43T63331	LEAD COVER	223	43T62341	TERMINAL COVER ASSY
210	43T22319	BELL MOUTH ASSY	224	43T62342	TERMINAL COVER (UP)
211	43T44466	REFRIGERANT CYCLE ASSY (FOR MML-AP0074,0094,0124NH-E)	225	43T08419	DISPLAY
211	43T44467	REFRIGERANT CYCLE ASSY (FOR MML-AP0154,0184NH-E)	226	43T82316	PLATE MOUNTING
212	43T46377	MOTOR, PMV	227	43T66304	REMOCON-WRS
213	43T46378	BODY PMV (FOR MML-AP0074,0094,0124NH-E)	228	43T83003	HOLDER, REMOTE CONTROL
213	43T46379	BODY PMV (FOR MML-AP0154,0184NH-E)	229	43T49342	COVER PIPE F ASSY
214	43T79316	DRAIN GUIDE (UP)	230	43T49343	COVER PIPE U ASSY
			231	43T49344	COVER PIPE D ASSY
			232	43T85512	OWNER'S MANUAL
			233	43T85513	OWNER'S MANUAL

15-2. Indoor Unit

Model: MML-AP0074NH-TR, MML-AP0094NH-TR, MML-AP0124NH-TR, MML-AP0154NH-TR, MML-AP0184NH-TR

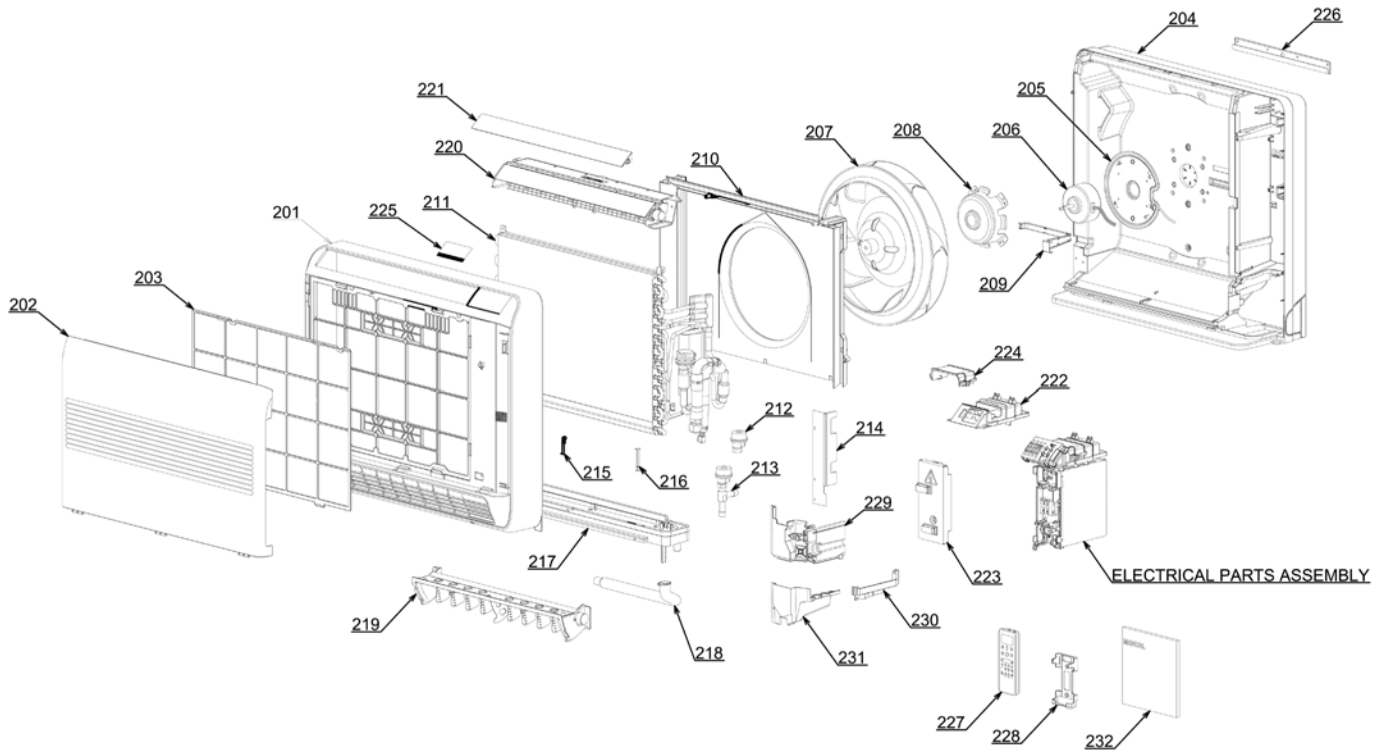

Location No.	Part No.	Description	Location No.	Part No.	Description
201	43T00558	FRONT PANEL ASSY	214	43T79316	DRAIN GUIDE (UP)
202	43T09460	INLET GRILLE ASSY	215	43T19333	HOLDER, SENSOR
203	43T80325	AIR FILTER	216	43T19321	FIX-P-SENSOR
204	43T03383	BACK BODY ASSY	217	43T72310	DRAIN PAN ASSY
205	43T39340	MOTOR BASE ASSY	218	43T70313	HOSE, DRAIN
206	43T21424	FAN MOTOR ASSY	219	43T22318	DAMPER ASSY
207	43T20330	TURBO FAN ASSY	220	43T22320	UPPER LOUVER ASSY
208	43T60408	MOTOR HOLDER	221	43T22315	HORIZONTAL LOUVER
209	43T63331	LEAD COVER	222	43T63336	DISPLAY BASE
210	43T22319	BELL MOUTH ASSY	223	43T62341	TERMINAL COVER ASSY
211	43T44466	REFRIGERANT CYCLE ASSY (FOR MML-0074,0094,0124NH-TR)	224	43T62342	TERMINAL COVER (UP)
211	43T44467	REFRIGERANT CYCLE ASSY (FOR MML-0154,0184NH-TR)	225	43T08419	DISPLAY
212	43T46377	MOTOR, PMV	226	43T82316	PLATE MOUNTING
213	43T46378	BODY PMV (FOR MML-0074,0094,0124NH-TR)	227	43T66304	REMOCON-WRS
213	43T46379	BODY PMV (FOR MML-0154,0184NH-TR)	228	43T83003	HOLDER, REMOTE CONTROL
			229	43T49342	COVER PIPE F ASSY
			230	43T49343	COVER PIPE U ASSY
			231	43T49344	COVER PIPE D ASSY
			232	43T85512	OWNER'S MANUAL

15-3. Indoor Unit (E-Part)

Model: MML-AP0074NH-E, MML-AP0094NH-E, MML-AP0124NH-E, MML-AP0154NH-E,
MML-AP0184NH-E

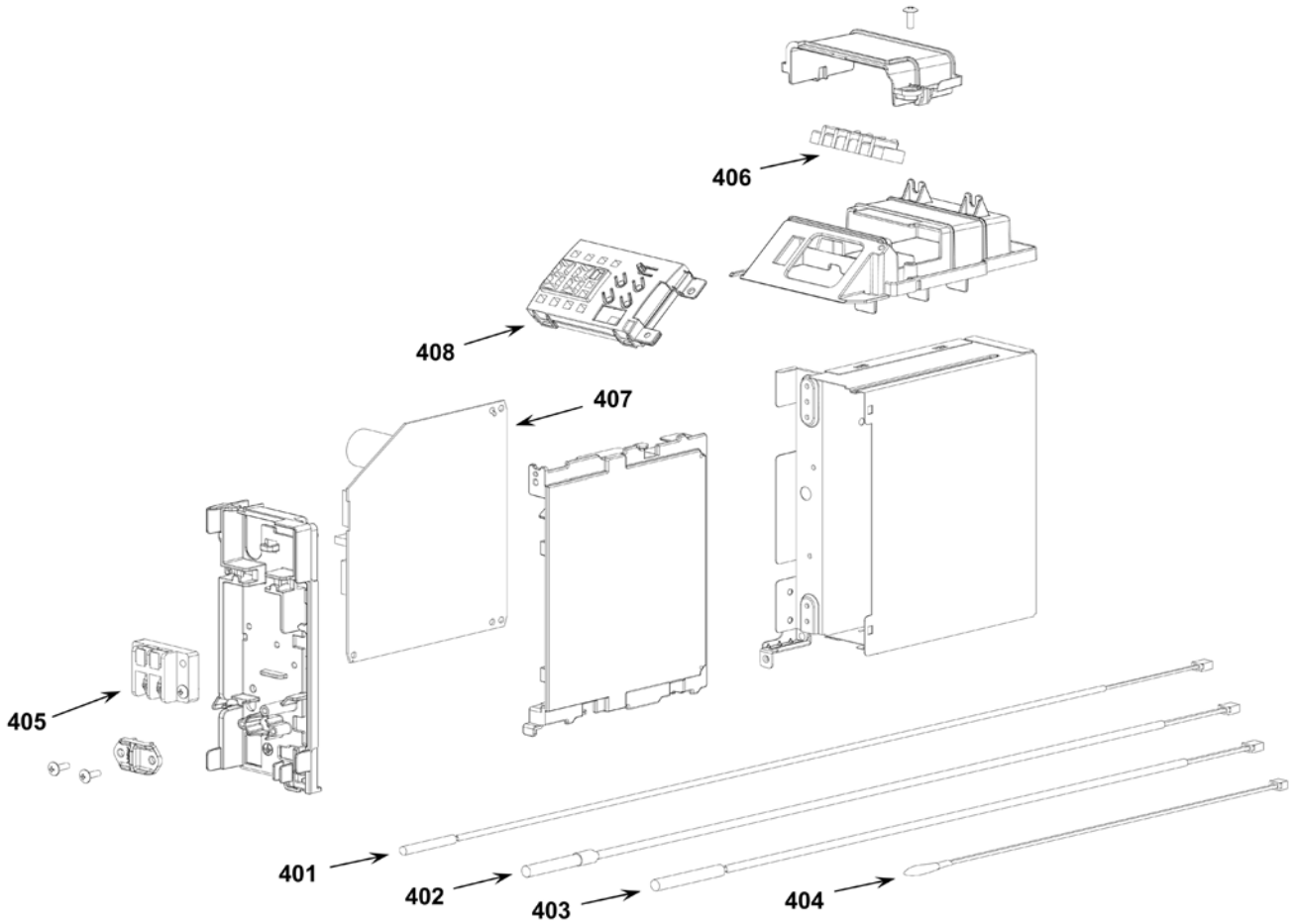

Location No.	Part No.	Description	Location No.	Part No.	Description
401	43T50317	SENSOR;HEAT EXCHANGER	405	43T60078	TERMIMAL BLOCK
402	43T50306	TEMPERATURE SENSOR	406	43T60079	TERMIMAL BLOCK
403	43T50308	SENSOR HEAT EXCHANGER	407	43T69899	PC BOARD
404	43T69320	TEMPERATURE SENSOR	408	43T69900	PC BOARD ASSY,WRS-LED

15-4. Indoor Unit (E-Part)

Model: MML-AP0074NH-TR, MML-AP0094NH-TR, MML-AP0124NH-TR, MML-AP0154NH-TR,
MML-AP0184NH-TR

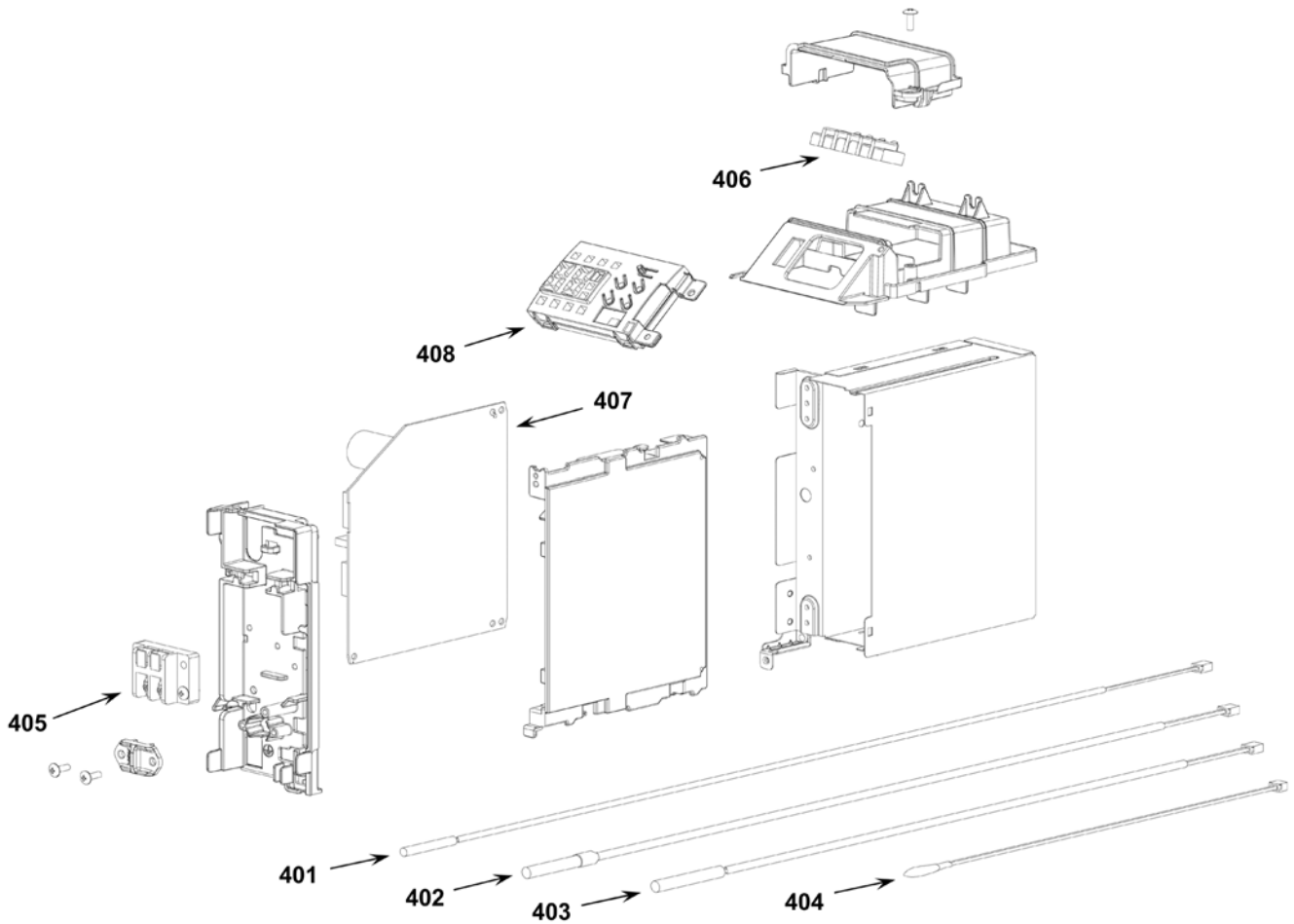

Location No.	Part No.	Description	Location No.	Part No.	Description
401	43T50317	SENSOR;HEAT EXCHANGER	405	43T60078	TERMIMAL BLOCK
402	43T50306	TEMPERATURE SENSOR	406	43T60079	TERMIMAL BLOCK
403	43T50308	SENSOR HEAT EXCHANGER	407	43T69899	PC BOARD
404	43T69320	TEMPERATURE SENSOR	408	43T69900	PC BOARD ASSY,WRS-LED

TOSHIBA CARRIER (THAILAND) CO., LTD.